

Access Controller (C)

User's Manual







Foreword

General

This manual introduces the structure, functions and operations of the access controller (hereinafter referred to as "the Controller").

Safety Instructions

The following categorized signal words with defined meaning might appear in the manual.

Signal Words	Meaning
 DANGER	Indicates a high potential hazard which, if not avoided, will result in death or serious injury.
 WARNING	Indicates a medium or low potential hazard which, if not avoided, could result in slight or moderate injury.
 CAUTION	Indicates a potential risk which, if not avoided, could result in property damage, data loss, reductions in performance, or unpredictable results.
 TIPS	Provides methods to help you solve a problem or save time.
 NOTE	Provides additional information as a supplement to the text.

Revision History

Version	Revision Content	Release Time
V1.0.2	Updated wiring image.	June 2022
V1.0.1	Added initialization process.	December 2021
V1.0.0	First release.	March 2021

Privacy Protection Notice

As the device user or data controller, you might collect the personal data of others such as their face, fingerprints, and license plate number. You need to be in compliance with your local privacy protection laws and regulations to protect the legitimate rights and interests of other people by implementing measures which include but are not limited: Providing clear and visible identification to inform people of the existence of the surveillance area and provide required contact information.

About the Manual

- The manual is for reference only. Slight differences might be found between the manual and the product.
- We are not liable for losses incurred due to operating the product in ways that are not in compliance with the manual.
- The manual will be updated according to the latest laws and regulations of related jurisdictions. For detailed information, see the paper user's manual, use our CD-ROM, scan the QR code or visit our official website. The manual is for reference only. Slight differences might be found between the electronic version and the paper version.
- All designs and software are subject to change without prior written notice. Product updates might result in some differences appearing between the actual product and the manual. Please contact customer service for the latest program and supplementary documentation.
- There might be errors in the print or deviations in the description of the functions, operations and technical data. If there is any doubt or dispute, we reserve the right of final explanation.
- Upgrade the reader software or try other mainstream reader software if the manual (in PDF format) cannot be opened.
- All trademarks, registered trademarks and company names in the manual are properties of their respective owners.
- Please visit our website, contact the supplier or customer service if any problems occur while using the Controller.
- If there is any uncertainty or controversy, we reserve the right of final explanation.

Important Safeguards and Warnings

This section introduces content covering the proper handling of the Controller, hazard prevention, and prevention of property damage. Read carefully before using the Controller, comply with the guidelines when using it, and keep the manual safe for future reference.

Transportation Requirement



Transport the Controller under allowed humidity and temperature conditions.

Storage Requirement



Store the Controller under allowed humidity and temperature conditions.

Installation Requirements



- Do not connect the power adapter to the Controller while the adapter is powered on.
- Strictly comply with the local electric safety code and standards. Make sure the ambient voltage is stable and meets the power supply requirements of the Controller.
- Do not connect the Controller to two or more kinds of power supplies, to avoid damage to the Controller.
- Improper use of the battery might result in a fire or explosion.



- Personnel working at heights must take all necessary measures to ensure personal safety including wearing a helmet and safety belts.
- Do not place the Controller in a place exposed to sunlight or near heat sources.
- Keep the Controller away from dampness, dust, and soot.
- Install the Controller on a stable surface to prevent it from falling.
- Install the Controller in a well-ventilated place, and do not block its ventilation.
- Use an adapter or cabinet power supply provided by the manufacturer.
- Use the power cords that are recommended for the region and conform to the rated power specifications.

- The power supply must conform to the requirements of ES1 in IEC 62368-1 standard and be no higher than PS2. Please note that the power supply requirements are subject to the Controller label.
- The Controller is a class I electrical appliance. Make sure that the power supply of the Controller is connected to a power socket with protective earthing.
- The Controller must be grounded when it is connected to 220 V mains electricity.

Table of Contents

Foreword	I
Important Safeguards and Warnings	III
1 Overview	1
1.1 Introduction.....	1
1.1 Features.....	1
1.2 Dimensions.....	1
1.3 Application.....	2
1.3.1 Two-door One-way.....	2
1.3.2 Two-door Two-way.....	3
1.3.3 Four-door One-way.....	3
1.3.4 Four-door Two-way.....	4
1.3.5 Eight-door one-way.....	4
2 Structure	5
2.1 Wiring.....	5
2.1.1 Two-door One-way.....	5
2.1.2 Two-door Two-way.....	6
2.1.3 Four-door One-way.....	7
2.1.4 Four-door Two-way.....	8
2.1.5 Eight-door One-way.....	9
2.1.6 Lock.....	9
2.1.7 Alarm Input.....	10
2.1.8 Alarm Output.....	10
2.1.9 Card Reader.....	12
2.2 Power Indicator.....	12
2.3 DIP Switch.....	12
2.4 Power Supply.....	13
2.4.1 Door Lock Power Port.....	13
2.4.2 Card Reader Power Port.....	13
3 SmartPSS AC Configuration	14
3.1 Login.....	14
3.2 Initialization.....	14
3.3 Adding Devices.....	15
3.3.1 Auto Search.....	15
3.3.2 Manual Add.....	16
3.4 User Management.....	18
3.4.1 Setting Card Type.....	18
3.4.2 Adding User.....	19
3.5 Configuring Permission.....	22
3.5.1 Adding Permission Group.....	22
3.5.2 Assigning Access Permission.....	23
3.6 Access Controller Configuration.....	24
3.6.1 Configuring Advanced Functions.....	24
3.6.2 Configuring Access Controller.....	30
3.6.3 Viewing Historical Event.....	33

3.7 Access Management.....	34
3.7.1 Remotely Opening and Closing Door	34
3.7.2 Setting Door Status.....	35
3.7.3 Configuring Alarm Linkage.....	36
4 ConfigTool Configuration	39
4.1 Initialization.....	39
4.2 Adding Devices.....	39
4.2.1 Adding Device Individually	40
4.2.2 Adding Devices in Batches	40
4.3 Configuring Access Controller	42
4.4 Changing Device Password.....	43
Appendix 1 Cybersecurity Recommendations	45

1 Overview

1.1 Introduction

The Controller is an access control panel which compensates video surveillance and visual intercom. It has neat and modern design with strong functionality, suitable for high-end commercial building, group properties and smart communities.

1.1 Features

- Adopts SEEC steel board to deliver a high-end appearance.
- Supports TCP/IP network communication. Communication data is encrypted for security.
- Auto registration.
- Supports OSDP protocol.
- Supports card, password and fingerprint unlock.
- Supports 100,000 users, 100,000 cards, 3,000 fingerprints, and 500,000 records.
- Supports interlock, anti-passback, multi-user unlock, first card unlock, admin password unlock, remote unlock, and more.
- Supports tamper alarm, intrusion alarm, door sensor timeout alarm, duress alarm, blocklist alarm, invalid card exceeding threshold alarm, incorrect password alarm and external alarm.
- Supports user types such as general users, VIP users, guest users, blocklist users, patrol users, and other users.
- Supports built-in RTC, NTP time calibration, manual time calibration, and automatic time calibration functions.
- Supports offline operation, event record storage and upload functions, and automatic network replenishment (ANR).
- Support 128 periods, 128 holiday plans, 128 holiday periods, normally open periods, normally closed periods, remote unlock periods, first card unlock periods, and unlock in periods.
- Supports watchdog guard mechanism to ensure the operation stability.

1.2 Dimensions

There are five kinds of access controllers, including two-door one-way, two-door two-way, four-door one-way, four-door two-way, and eight-door one-way. Their dimensions are the same.

Figure 1-1 Dimensions (mm [inch])

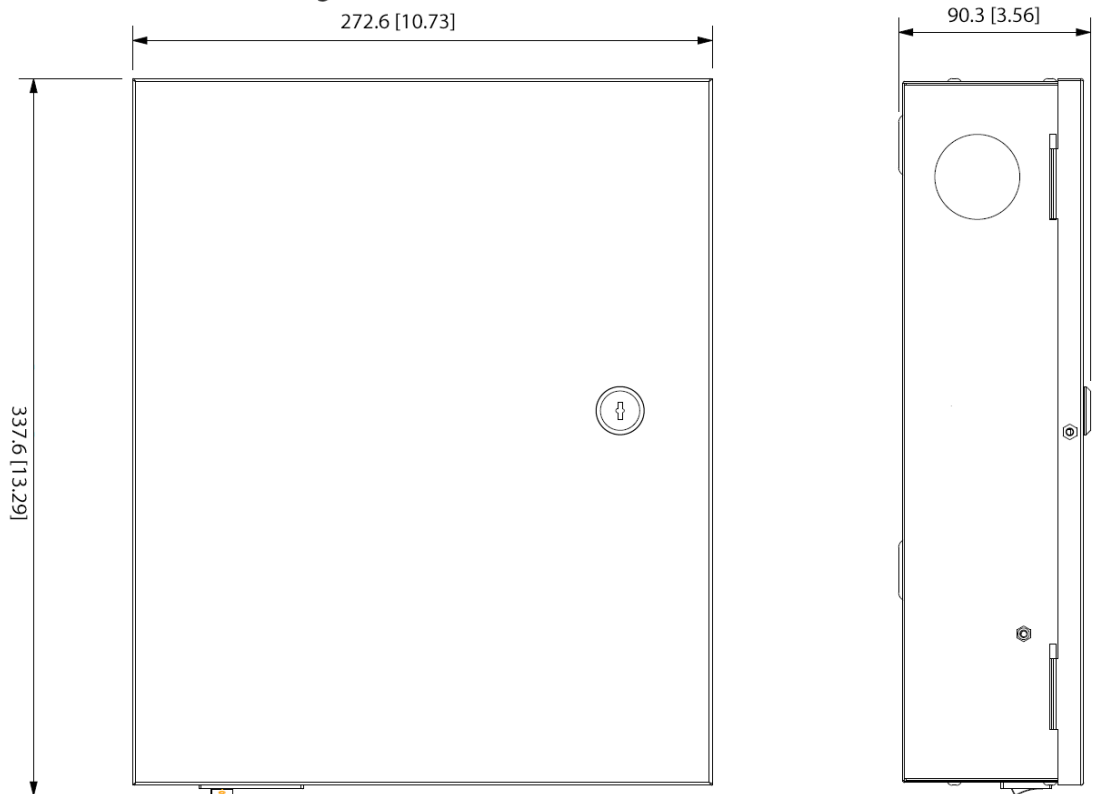

1.3 Application

1.3.1 Two-door One-way

Figure 1-2 Application of two-door one-way controller

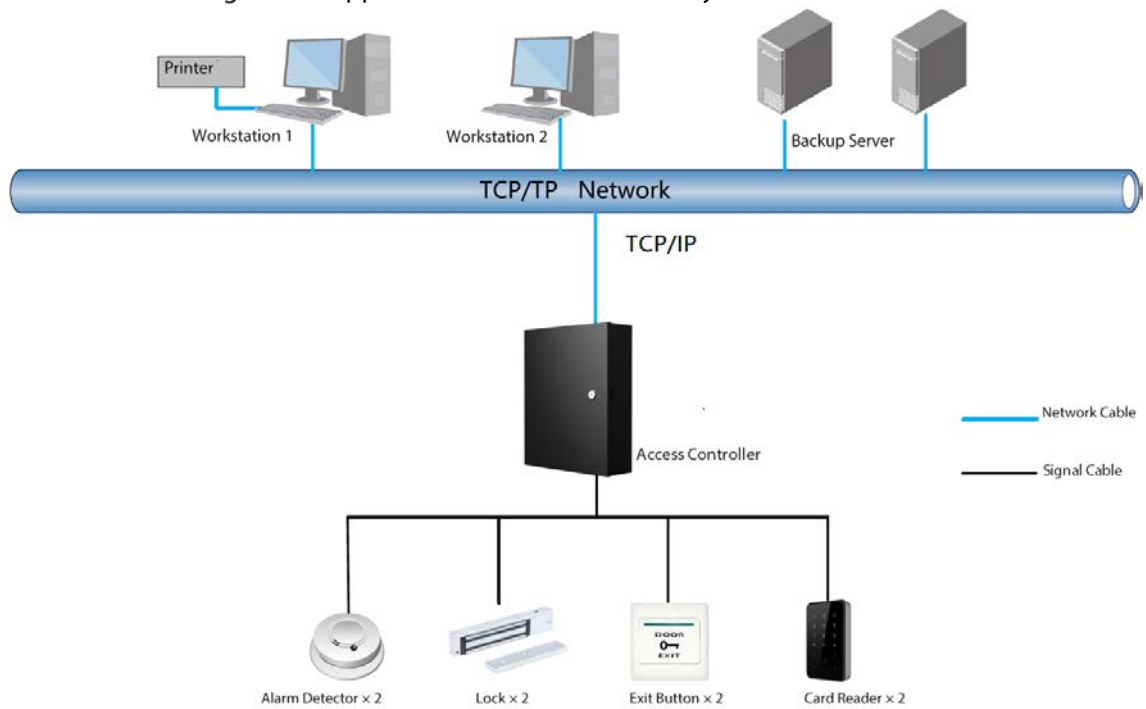

1.3.2 Two-door Two-way

Figure 1-3 Application of two-door two-way controller

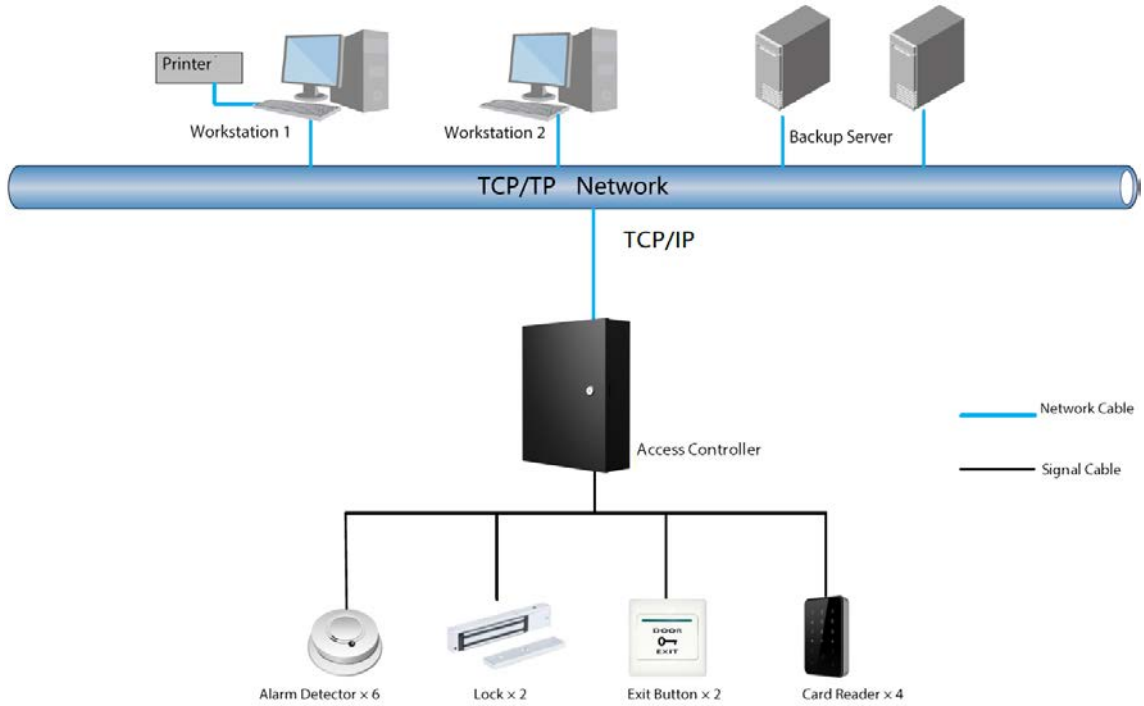

1.3.3 Four-door One-way

Figure 1-4 Application of four-door one-way controller

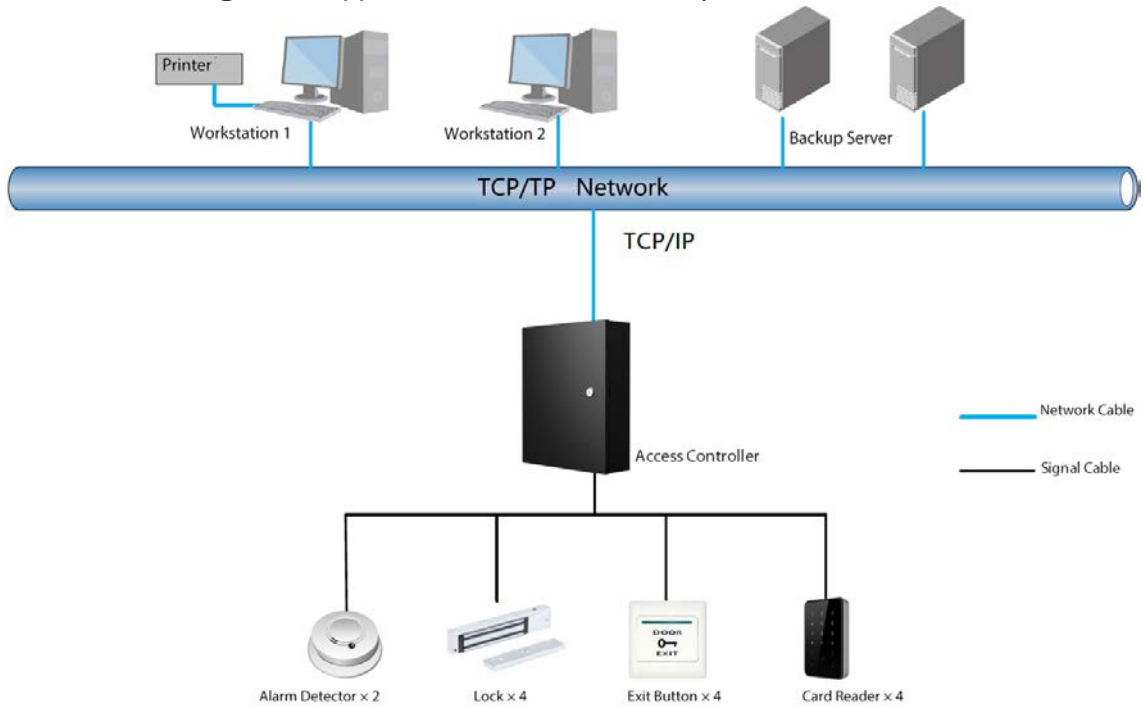

1.3.4 Four-door Two-way

Figure 1-5 Application of four-door two-way controller

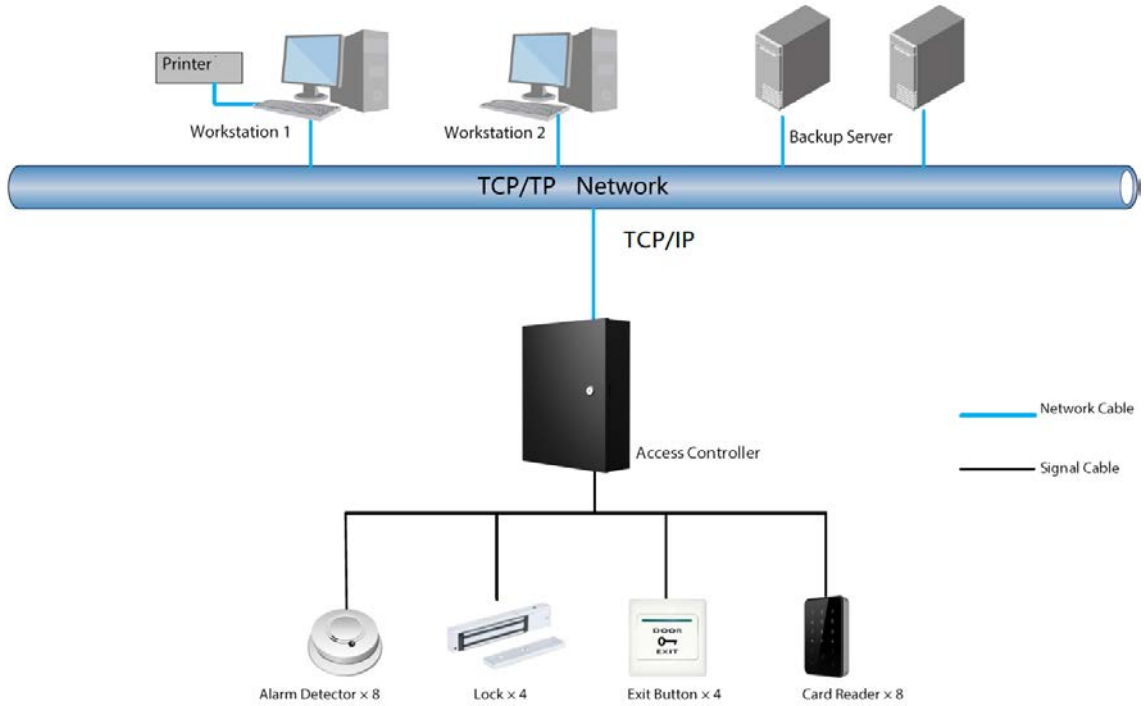

1.3.5 Eight-door one-way

Figure 1-6 Application of eight-door one-way controller

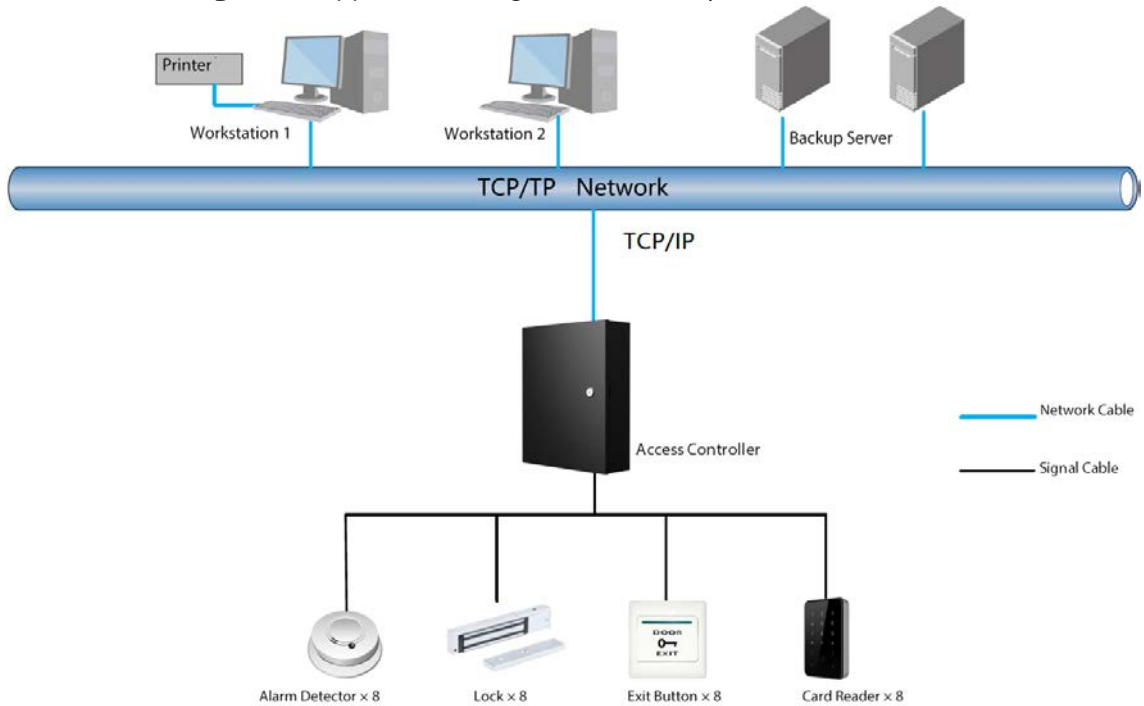

2 Structure

2.1 Wiring



- Connect the wires only when powered off.
- Make sure that the plug of the power supply is grounded.
- 12 V: Maximum current for an extension module is 100 mA.
- 12 V_RD: Maximum current for a card reader is 2.5 A.
- 12 V_LOCK: Maximum current for a lock is 2 A.

Table 2-1 Wire specification

Device	Cable
Card reader	Cat5 8-core shielded tw
Ethernet cable	Cat5 8-core shielded tw
Button	2-core
Door contact	2-core

2.1.1 Two-door One-way

Figure 2-1 Wire a two-door one-way controller

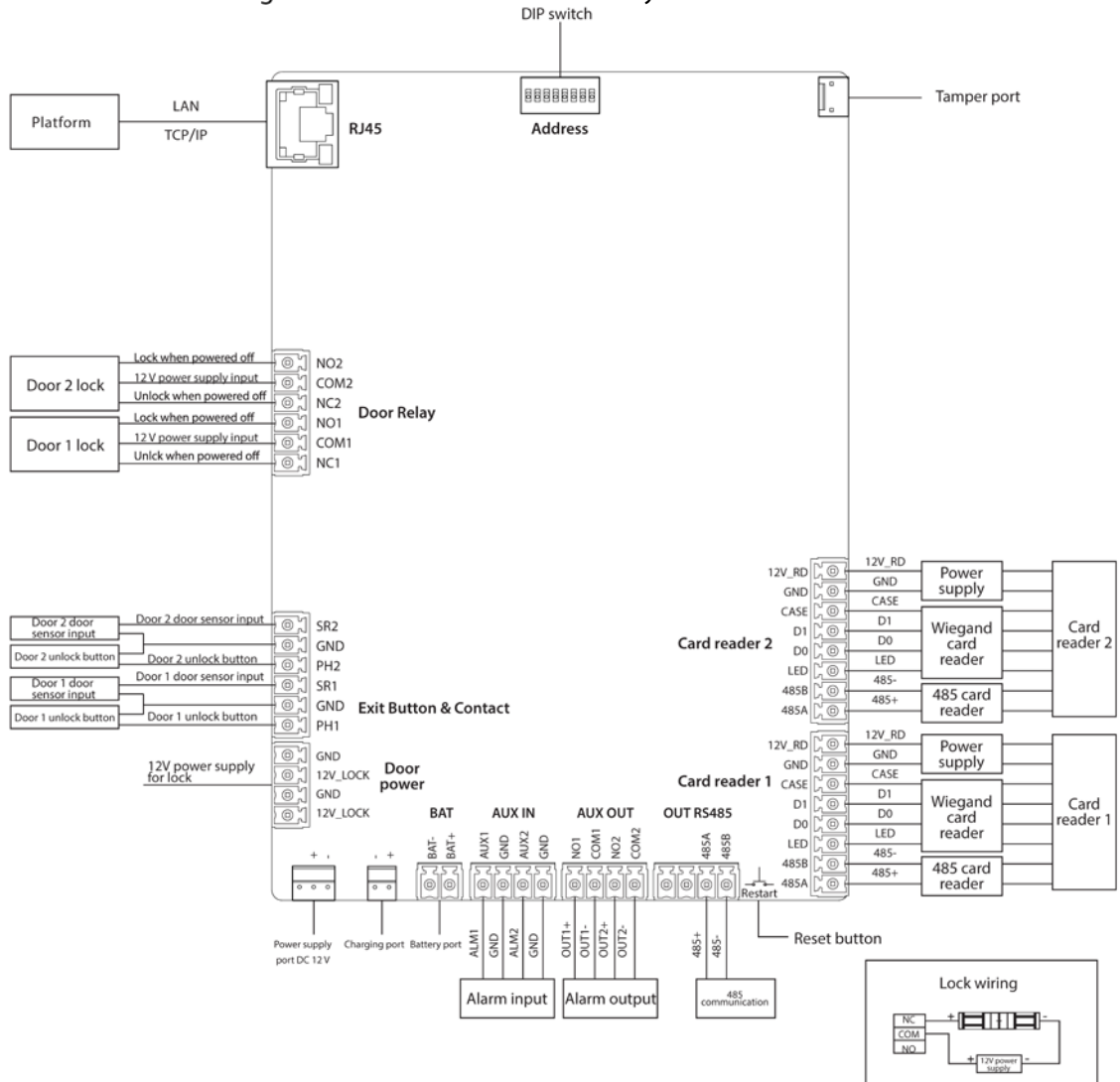

2.1.2 Two-door Two-way

Figure 2-2 Wire a two-door two-way controller

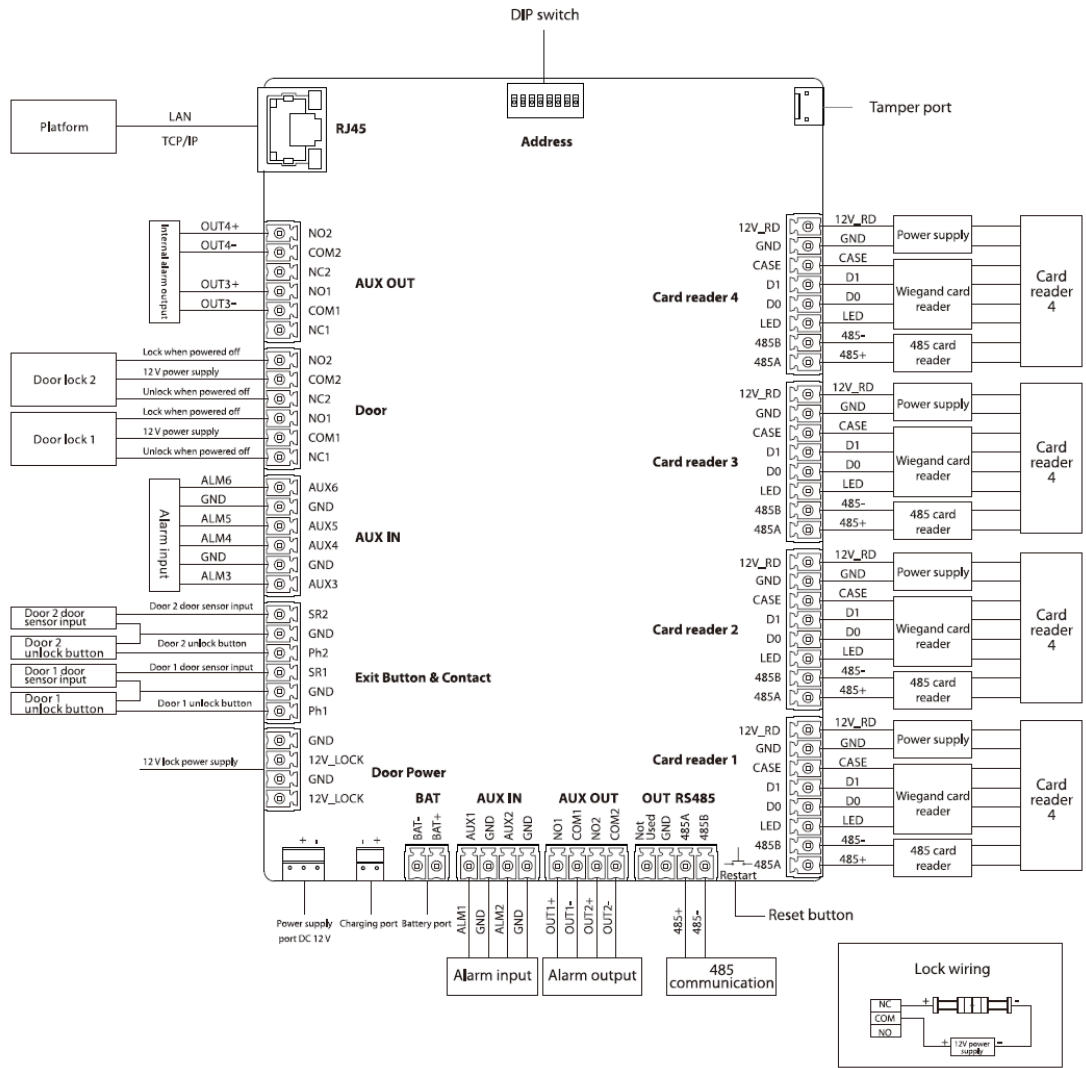

2.1.3 Four-door One-way

Figure 2-3 Wire a four-door one-way controller

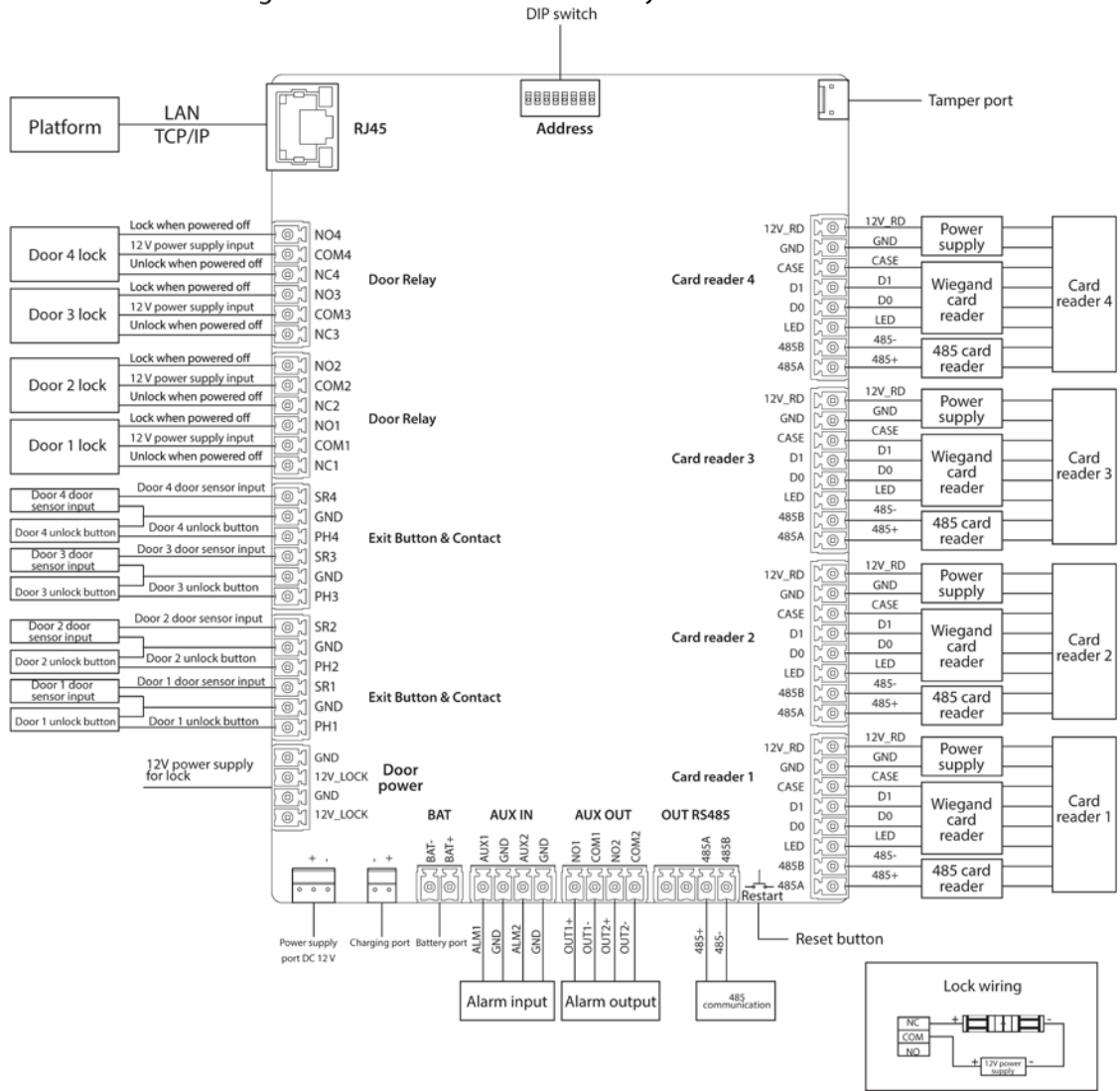

2.1.4 Four-door Two-way

Figure 2-4 Wire a four-door two-way controller

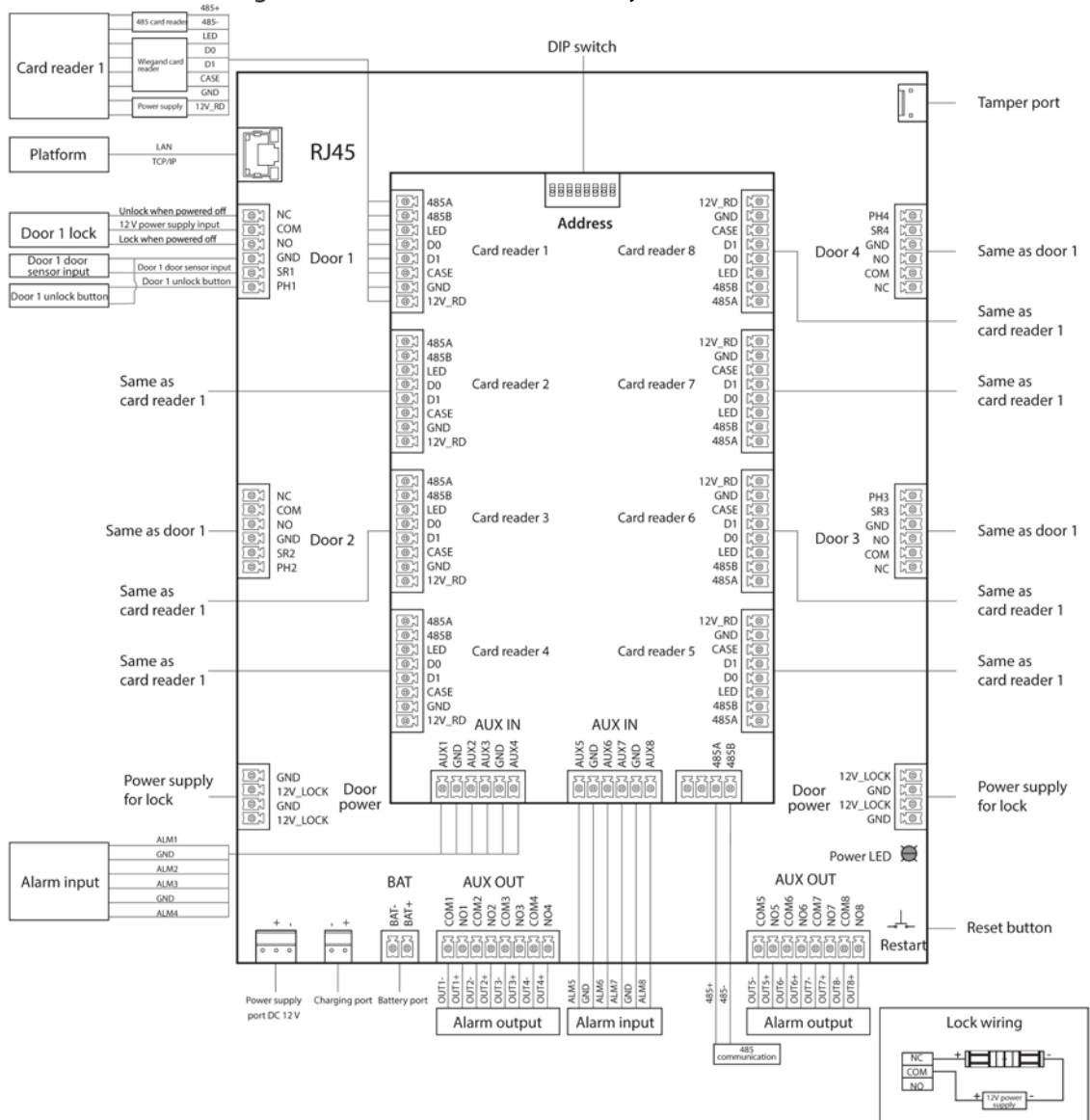

1

2.1.5 Eight-door One-way

Figure 2-5 Wire an eight-door one-way controller

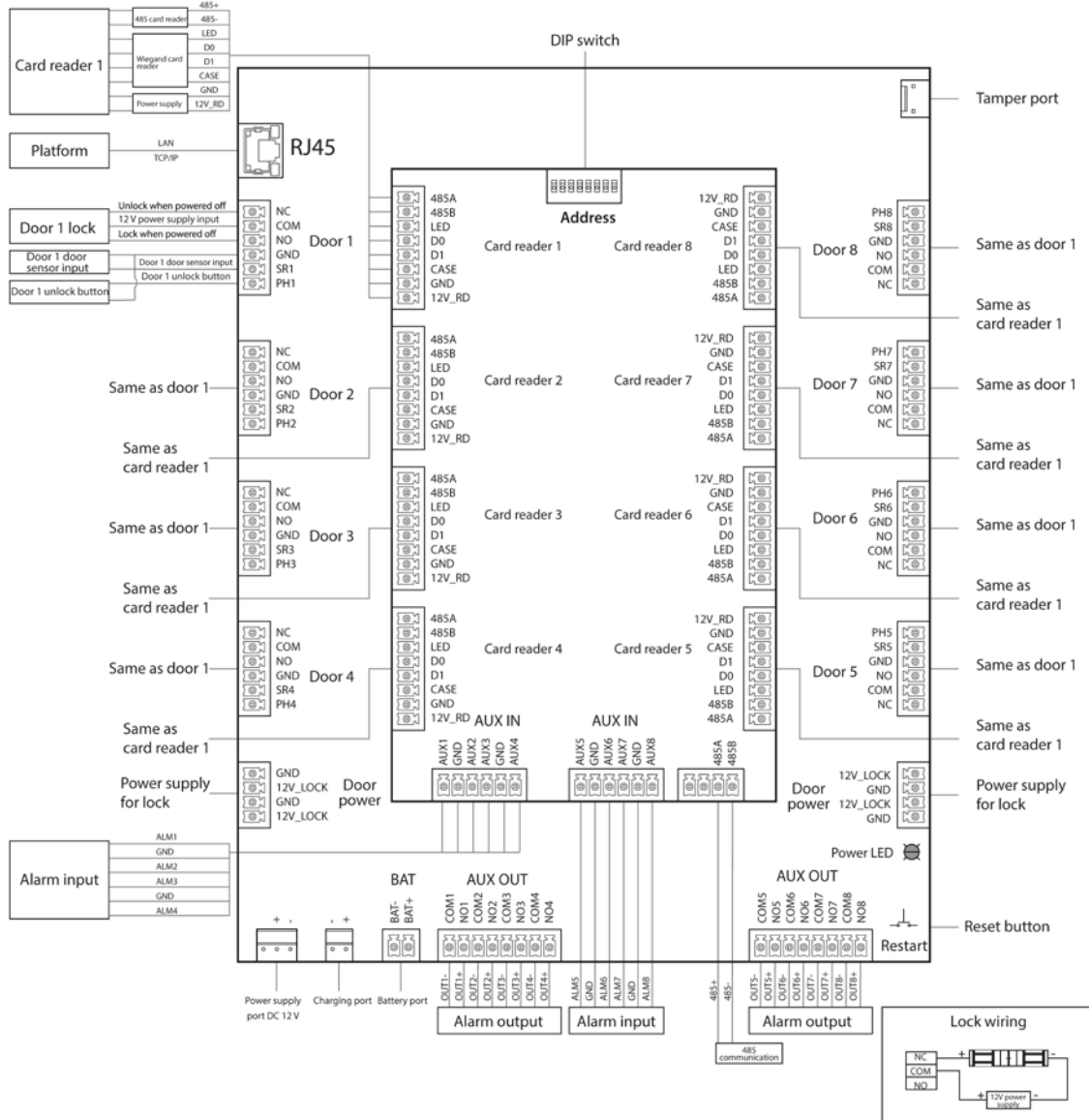

2.1.6 Lock

Select the wiring method according to your lock type.

Figure 2-6 Electric lock

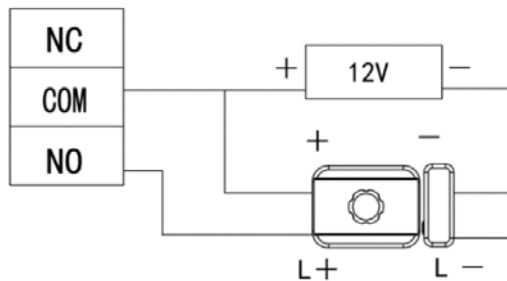

Figure 2-7 Magnetic lock

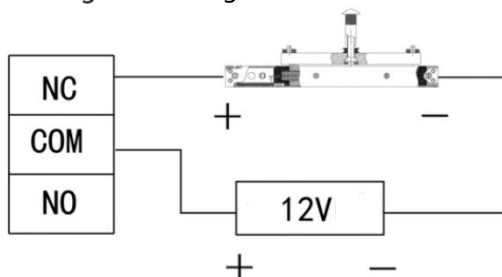
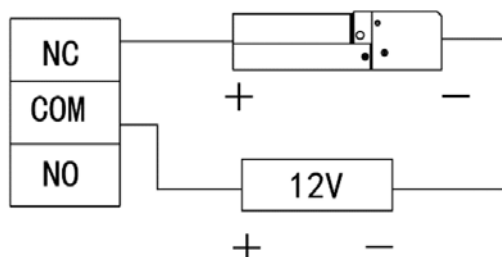

Figure 2-8 Electric bolt



2.1.7 Alarm Input

The alarm input port connects to external alarm devices, such as smoke detector and IR detector. Some alarm in ports can link door open/close status.

Table 2-2 Wiring alarm input

Type	Number of Alarm Input Channels	Description
Two-door One-way	2	Linkable door status: <ul style="list-style-type: none"> ● AUX1 external alarm links Normally Open for all doors. ● AUX2 external alarm links Normally Closed for all doors.
Two-door Two-way	6	Linkable door status: <ul style="list-style-type: none"> ● AUX1–AUX2 external alarm links Normally Open for all doors. ● AUX3–A UX4 external alarm links Normally Closed for all doors.
Four-door One way	2	Linkable door status: <ul style="list-style-type: none"> ● AUX1 external alarm links Normally Open for all doors. ● AUX2 external alarm links Normally Closed for all doors.
Four-door Two-way	8	Linkable door status: <ul style="list-style-type: none"> ● AUX1–AUX2 external alarm links Normally Open for all doors. ● AUX3–A UX4 external alarm links Normally Closed for all doors.
Eight-door One-way	8	Linkable door status: <ul style="list-style-type: none"> ● AUX1–AUX2 external alarm links Normally Open for all doors. ● AUX3–A UX4 external alarm links Normally Closed for all doors.

2.1.8 Alarm Output

When an alarm is triggered from the internal or external alarm input port, the alarm output device will report the alarm, and the alarm will last for 15 s.



When wiring the two-way dual-door device to the internal alarm output device, select NC/NO according to the Always Open or Always Close status.

- NC: Normally Closed.
- NO: Normally Open.

Table 2-3 Wiring alarm output

Type	Number of Alarm Output Channels	Description	
Two-door One-way	2	NO1	<ul style="list-style-type: none"> ● AUX1 triggers alarm output. ● Door timeout and intrusion alarm output for door 1. ● Card Reader 1 tamper alarm output.
		COM1	
		NO2	<ul style="list-style-type: none"> ● AUX2 triggers alarm output. ● Door timeout and intrusion alarm output for door 2. ● Card Reader 2 tamper alarm output.
		COM2	
Two-door Two-way	2	NO1	AUX1/AUX2 triggers alarm output.
		COM1	
		NO2	AUX3/AUX4 triggers alarm output.
		COM2	
	2	NC1	<ul style="list-style-type: none"> ● Card Reader 1/2 tamper alarm output. ● Door 1 timeout and intrusion alarm output.
		COM1	
NO1		<ul style="list-style-type: none"> ● Card Reader 3/4 tamper alarm output. ● Door 2 timeout and intrusion alarm output. 	
NC2			
COM2			
NO2			
Four-door One way	2	NO1	<ul style="list-style-type: none"> ● AUX1 triggers alarm output. ● Door timeout and intrusion alarm output. ● Card Reader tamper alarm output.
		COM1	
		NO2	
		COM2	AUX2 triggers alarm output.
Four-door Two-way	8	NO1	<ul style="list-style-type: none"> ● AUX1 triggers alarm output. ● Card Reader 1/2 tamper alarm output. ● Door 1 timeout and intrusion alarm output. ● Device tamper alarm output.
		COM1	
		NO2	
		COM2	
		NO3	<ul style="list-style-type: none"> ● AUX2 triggers alarm output. ● Card Reader 1/2 tamper alarm output. ● Door 2 timeout and intrusion alarm output.
		COM3	
		NO4	
		COM4	<ul style="list-style-type: none"> ● AUX3 triggers alarm output. ● Card Reader 5/6 tamper alarm output. ● Door 3 timeout and intrusion alarm output.
		NO5	
		COM5	AUX4 triggers alarm output.
		NO6	AUX5 triggers alarm output.
		COM6	
		NO7	AUX6 triggers alarm output.
		COM7	
		NO8	AUX7 triggers alarm output.
		COM8	
NO8	AUX8 triggers alarm output.		
COM8			

Type	Number of Alarm Output Channels	Description	
Eight-door One-way	8	NO1	<ul style="list-style-type: none"> ● AUX1 triggers alarm output. ● Card Reader 1 tamper alarm output. ● Door 1 timeout and intrusion alarm output. ● Device tamper alarm output.
		COM1	
		NO2	<ul style="list-style-type: none"> ● AUX2 triggers alarm output. ● Card Reader 2 tamper alarm output. ● Door 2 timeout and intrusion alarm output.
		COM2	
		NO3	<ul style="list-style-type: none"> ● AUX3 triggers alarm output. ● Card Reader 3 tamper alarm output. ● Door 3 timeout and intrusion alarm output.
		COM3	
		NO4	<ul style="list-style-type: none"> ● AUX4 triggers alarm output. ● Card Reader 4 tamper alarm output. ● Door 4 timeout and intrusion alarm output.
		COM4	
		NO5	<ul style="list-style-type: none"> ● AUX5 triggers alarm output. ● Card Reader 5 tamper alarm output. ● Door 5 timeout and intrusion alarm output.
		COM5	
		NO6	<ul style="list-style-type: none"> ● AUX6 triggers alarm output. ● Card Reader 6 tamper alarm output. ● Door 6 timeout and intrusion alarm output.
		COM6	
		NO7	<ul style="list-style-type: none"> ● AUX7 triggers alarm output. ● Card Reader 7 tamper alarm output. ● Door 7 timeout and intrusion alarm output.
		COM7	
		NO8	<ul style="list-style-type: none"> ● AUX8 triggers alarm output. ● Card Reader 8 tamper alarm output. ● Door 8 timeout and intrusion alarm output.
		COM8	

2.1.9 Card Reader



One door can only connect card readers of the same type, either RS-485 or Wiegand.

Table 2-4 Card reader wire specification description

Card Reader Type	Wiring Method	Length
RS-485 card reader	RS-485 connection. The impedance of a single wire must be within 10Ω.	100 m
Wiegand card reader	Wiegand connection. The impedance of a single wire must be within 2Ω.	80 m

2.2 Power Indicator

- Solid green: Normal.
- Red: Abnormal.
- Flashes green: Charging.
- Blue: The Controller is in the Boot mode.

2.3 DIP Switch



(ON) indicates 1;



indicates 0.

Figure 2-9 DIP switch

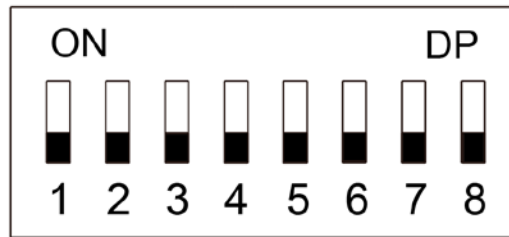

- When 1–8 are all switched to 0, the Controller starts normally after power-on.
- When 1–8 are all switched to 1, the Controller enters the BOOT mode after it starts.
- When 1, 3, 5 and 7 are switched to 1 and the others are 0, the Controller restores to factory defaults after it restarts.
- When 2, 4, 6 and 8 are switched to 1 and the others are 0, the Controller restores to factory defaults but keeps user information after it restarts.

2.4 Power Supply

2.4.1 Door Lock Power Port

The rated voltage of the door lock power port is 12 V, and the maximum current output is 2.5 A. If the power load exceeds the maximum rated current, provide extra power supply.

2.4.2 Card Reader Power Port

- Two-door one-way, two-door two-way, four-door one-way controllers: The rated voltage of the card reader power port (12V_RD) is 12 V, and the maximum current output is 1.4 A.
- Four-door two-way and eight-door one-way controllers: The rated voltage of the card reader power port (12V_RD) is 12 V, and the maximum current output is 2.5 A.

3 SmartPSS AC Configuration

You can manage the Controller through SmartPSS AC. This section mainly introduces quick configurations of the Controller. For details, refer to SmartPSS AC user manual.



The screenshots of Smart PSS AC client in this manual are only for reference, and might differ from the actual product.

3.1 Login

Step 1 Install the SmartPSS AC.

Step 2 Double-click , and then follow the instructions to finish the initialization and log in.

3.2 Initialization



Before initialization, make sure the Controller and the computer are on the same network.

Step 1 On the home page, select **Device Manager**, and then click **Auto Search**.

Figure 3-1 Auto search

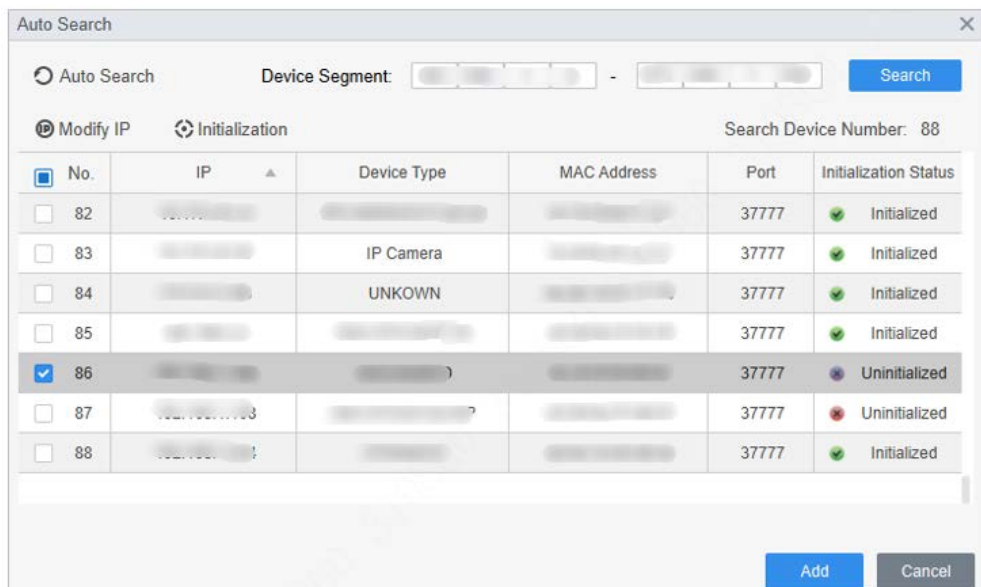

Step 2 Enter a network segment range, and then click **Search**.

Step 3 Select the device, and then click **Initialization**.

Step 4 Set the admin password, and then click **Next**.



If you forget the password, use the DIP switch to restore factory defaults.

Figure 3-2 Set password

1. Set a password. 2. Password security. 3. Modify IP address.

User Name: admin

Password: *

Confirm Password: *

Please input 8-32 bytes from letters or numbers or symbols.

Next + Cancel

Step 5 Associate the phone number, and then click **Next**.

Step 6 Enter new IP, subnet mask and gateway.

Figure 3-3 Modify IP Address

1. Set a password. 2. Password security. 3. Modify IP address.

New IP:

Subnet Mask:

Gateway:

Back Finish Cancel

Step 7 Click **Finish**.

3.3 Adding Devices

You need to add the Controller to SmartPSS AC. You can click **Auto Search** to add and click **Add** to manually add devices.

3.3.1 Auto Search

We recommend adding devices by auto search when you need to add devices in batches within the same network segment, or when the network segment is clear but the device IP address is unclear.

Step 1 Log in to SmartPSS AC.

Step 2 Click **Device Manager** on the lower-left corner.

Figure 3-4 Devices

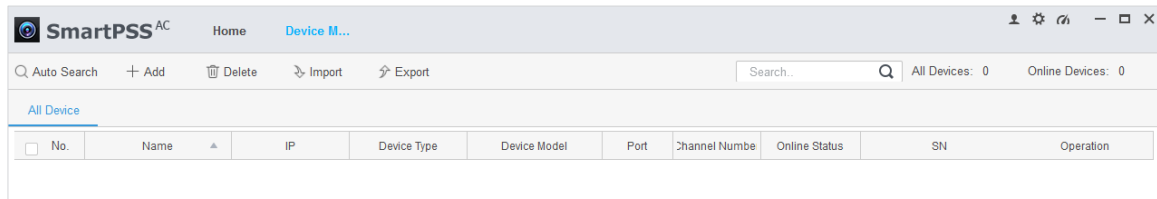

Step 3 Click **Auto Search**.

Figure 3-5 Auto search

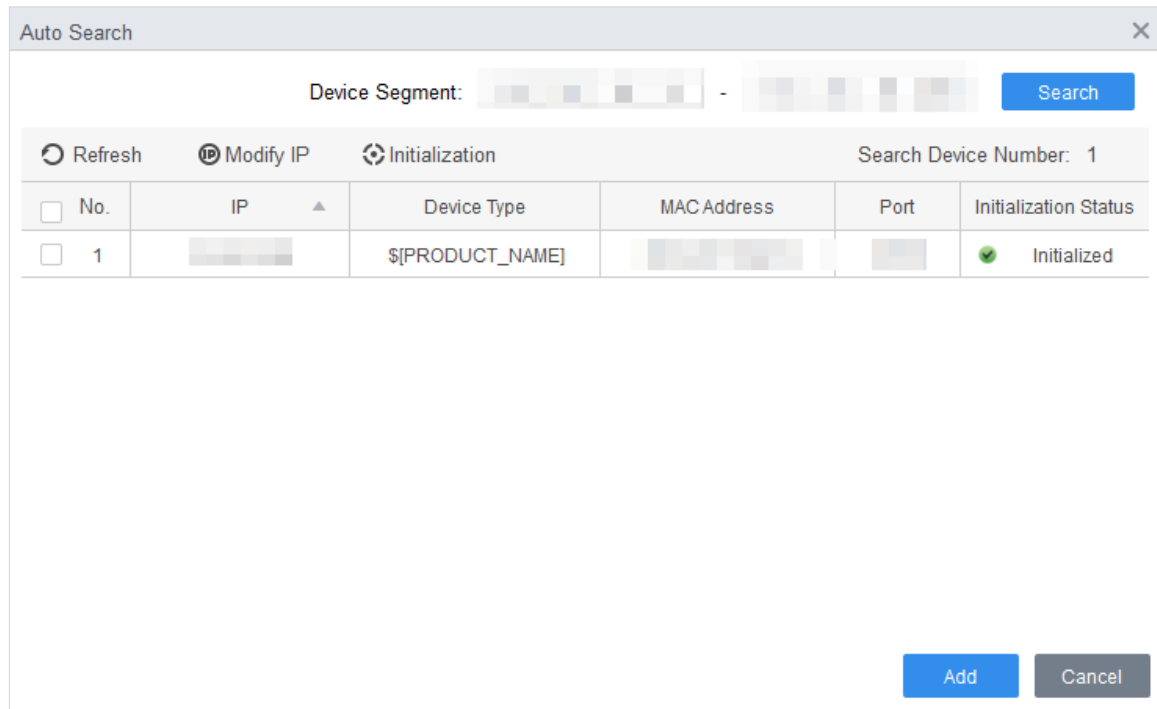

Step 4 Enter the network segment, and then click **Search**.

A search result list will be displayed.



- Click **Refresh** to update device information.
- Select a device, click **Modify IP** to modify IP address of the device.

Step 5 Select devices that you want to add to the SmartPSS AC, and then click **Add**.

Step 6 Enter the username and the login password to login.

You can see the added devices on the **Devices** page.



- The username is admin and password is admin123 by default. We recommend changing the password after login.
- After adding, SmartPSS AC logs in to the device automatically. After successful login, the status displays **Online**. Otherwise, it displays **Offline**.

3.3.2 Manual Add

You can add devices manually. You need to know IP addresses and domain names of access controllers that you want to add.

- Step 1** Log in to SmartPSS AC.
- Step 2** Click **Device Manager** on the lower-left corner.
- Step 3** Click **Add** on the **Device Manager** page.

Figure 3-6 Manual add

- Step 4** Enter detailed information of the Controller.

Table 3-1 Parameters

Parameter	Description
Device Name	Enter a name of the Controller. We recommend you name the Controller after its installation area for easy identification.
Method to add	Select IP to add the Controller through IP address.
IP	Enter IP address of the Controller. It is 192.168.1.108 by default.
Port	Enter the port number of the device. The port number is 37777 by default.
User Name, Password	Enter the username and password of the Controller.  The username is admin and password is admin123 by default. We recommend you change the password after login.

- Step 5** Click **Add**.
The added device is on the **Devices** page.



After adding, SmartPSS AC logs in to the device automatically. After successful login, the status displays **Online**. Otherwise, it displays **Offline**.

3.4 User Management

Add users, assign cards to them, and configure their access permissions.

3.4.1 Setting Card Type

Before assigning card, set card type first. For example, if the assigned card is ID card, select type as ID card.



The selected card type must be the same as the actual assigned card type; otherwise card numbers cannot be read.

Step 1 Log in to SmartPSS AC.

Step 2 Click **Personnel Manager**.

Figure 3-7 Personnel manager

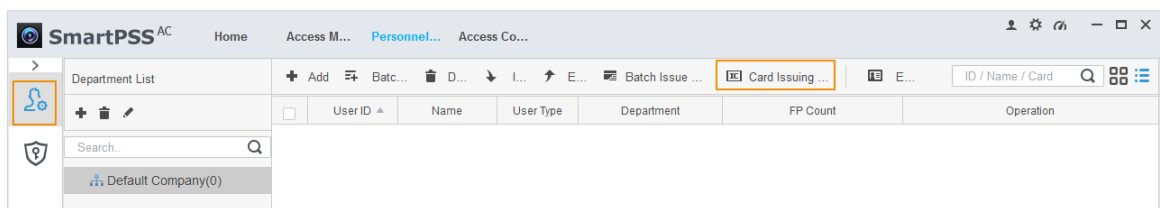

Step 3 On the **Personnel Manager** page, click , then click .

Step 4 On the **Setting Card Type** window, select a card type.

Step 5 Click  to select display method of card number in decimal or in hex.

Figure 3-8 Setting card type

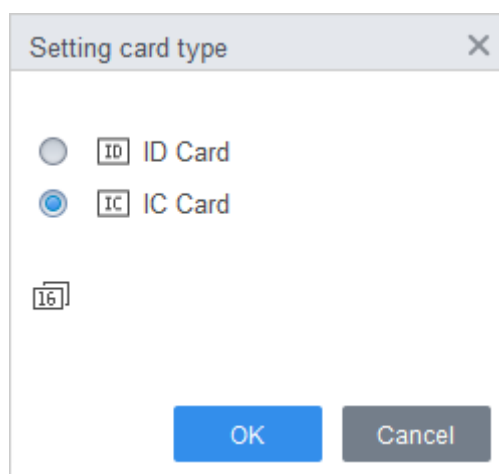

Step 6 Click **OK**.

3.4.2 Adding User

3.4.2.1 Adding Individually

You can add users individually.

Step 1 Log in to SmartPSS AC.

Step 2 Click **Personnel Manger > User > Add**.

Step 3 Add basic information of the user.

- 1) Click the **Basic Info** tab on the **Add User** page, and then add basic information of the user.
- 2) Click the image, and then click **Upload Picture** to add a face image.

The uploaded face image will display on the capture frame.



Make sure that the image pixels are more than 500 × 500; image size is less than 120 KB.

Figure 3-9 Add basic information

The screenshot shows the 'Add User' dialog box with the 'Basic Info' tab selected. The form contains the following fields and values:

- User ID: 2
- Name: test
- Department: Default Company
- User Type: General
- Valid Time: 2020/6/5 0:00:00 to 2030/6/5 23:59:59 (3653 Days)
- Gender: Male
- Title: Mr
- DOB: 1985-3-15
- Tel: (empty)
- Email: (empty)
- Mailing Address: (empty)
- Administrator: (toggle off)
- Remark: (empty text area)
- ID Type: ID
- ID No.: (empty)
- Company: (empty)
- Occupation: (empty)
- Entry Time: 2020/6/4 14:37:59
- Resign Time: 2030/6/5 14:37:59

A camera capture frame on the right shows a silhouette with an 'Upload Picture' button. The image size is 0 ~ 120KB.

Step 4 Click the **Certification** tab to add certification information of the user.

- Configure password.
Set password. For the second-generation access controllers, set the personnel password; for other devices, set the card password. The new password must consist of 6 digits.

- Configure card.



The card number can be read automatically or entered manually. To read the card number automatically, select a card reader, and then place the card on the card reader.

- 1) Click  to set **Device** or **Card issuer** to card reader.
 - 2) The card number must be added if the non-second generation access controller is used.
 - 3) After adding, you can set the card to main card or duress card, or replace the card with a new one, or delete the card.
- Configure fingerprint.

- 1) Click  to set **Device** or **Fingerprint Scanner** to fingerprint collector.
- 2) Click **Add Fingerprint** and press your finger on the scanner three times continuously.

Figure 3-10 Configure certification

- Step 5** Configure permissions for the user.
For details, see "3.5 Configuring Permission".

Figure 3-11 Permission configuration

Basic Info Certification **Permission configuration**

Permission group is a combination of various devices including attendance check and access control. After selecting the permission group, the personnel info will be sent to corresponding device and used for related functions of access control and attendance check.

Add Group

<input type="checkbox"/>	Permission Group	Memo
<input type="checkbox"/>	Permission Group1	
<input type="checkbox"/>	Permission Group2	

Step 6 Click **Finish**.

3.4.2.2 Adding in Batches

You can add users in batches.

Step 1 Log in to SmartPSS AC.

Step 2 Click **Personnel Manger > User > Batch Add**.

Step 3 Select card reader and the department of user. Set the start number, card quantity, effective time and expired time of card.

Step 4 Click **Issue** to assigning cards.

The card number will be read automatically.

Step 5 Click **Stop** after assigning card, and then click **OK**.

Figure 3-12 Add users in batches

Batch Add
✕

Device

Start No.:

Quantity:

Department:

Effective Time:

Expired Time:

Issue Card

ID	Card No.
5	
6	
7	
8	
9	
10	
11	
12	
13	
14	

3.5 Configuring Permission

3.5.1 Adding Permission Group

Create a permission group that is a collection of door access permissions.

Step 1 Log in to SmartPSS AC.

Step 2 Click **Personnel Manger** > **Permission Configuration**.

Figure 3-13 Permission group list

	Permission Group	Operation
+		Search.. <input type="text"/>
✕		<input type="text"/>
<input type="checkbox"/>	Permission Group	Operation
<input type="checkbox"/>	Permission Group1	✎ 👤 ✕
<input type="checkbox"/>	Permission Group2	✎ 👤 ✕

Step 3 Click  to add a permission group.

Step 4 Set permission parameters.

- 1) Enter group name and remark.
- 2) Select the time template.



For details of time template setting, see SmartPSS AC user's manual.

- 3) Select the corresponding device, such as door 1.

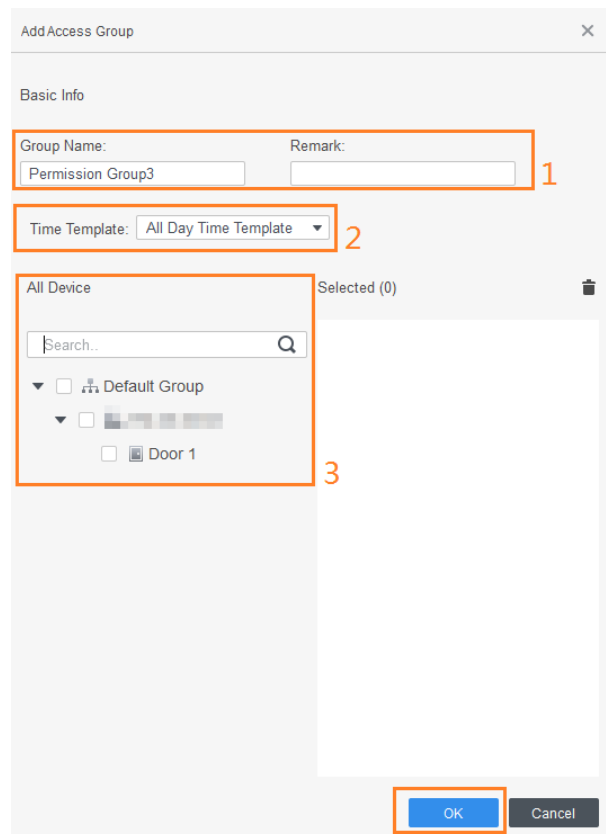

Figure 3-14 Add permission group



Step 5 Click **OK**.

Related Operation

On the **Permission Group List** page, you can:

- Click  to delete group.
- Click  to modify group information.
- Double-click permission group name to view group information.

3.5.2 Assigning Access Permission

Associate users with desired permission groups, and then the users will be assigned access permissions to defined doors.

Step 1 Log in to SmartPSS AC.

Step 2 Click **Personnel Manger** > **Permission Configuration**.

Step 3 Select the target permission group, and then click .

Figure 3-15 Configure permission

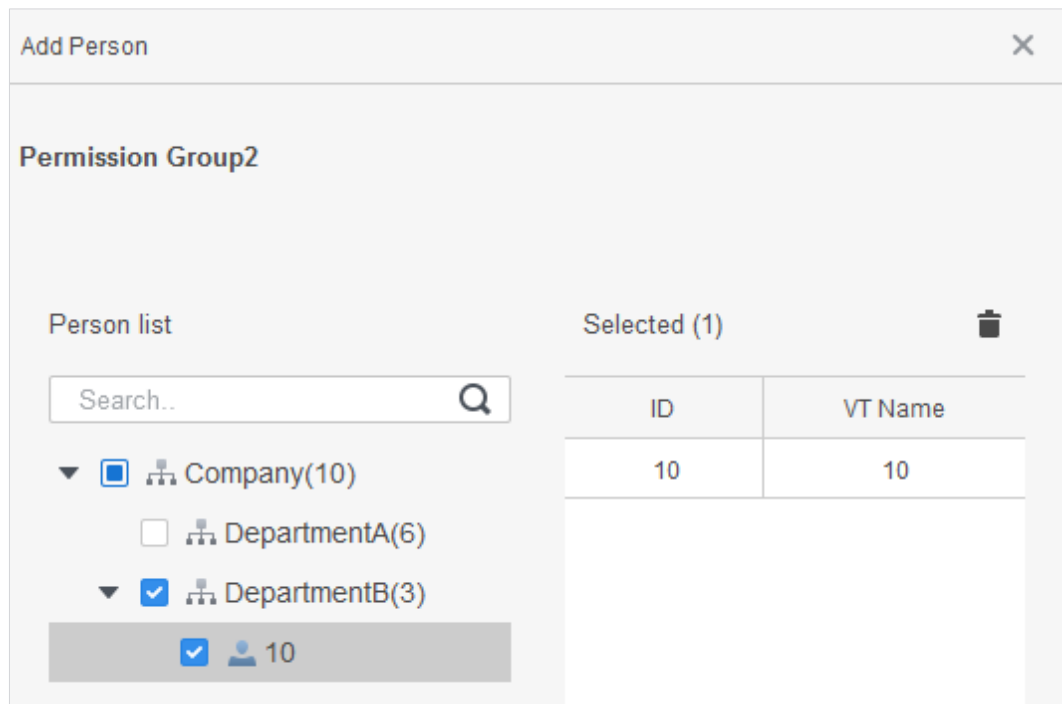

Step 4 Select users to associate them with the selected group.

Step 5 Click **OK**.

3.6 Access Controller Configuration

3.6.1 Configuring Advanced Functions

3.6.1.1 First Card Unlock

Other users can swipe to unlock the door only after the specified first card holder swipes the card. You can set multiple first-cards. Other users without first-cards can unlock the door only after one of the first-card holders swipe the first card.



- The person to be granted with the first card unlock permission should be of the **General** user type and have permissions of the certain doors. Set the type when adding users. For details, see "3.3.2 Adding User".
- For details of assigning permissions, see "3.5 Configuring Permission".

Step 1 Select **Access Configuration** > **Advanced Config**.

Step 2 Click the **First Card Unlock** tab.

Step 3 Click **Add**.

Step 4 Configure the **First Card Unlock** parameters, and then click **Save**.

Figure 3-16 First card unlock configuration

Table 3-2 Parameters of first-card unlock

Parameter	Description
Door	Select the target access control channel to configure the first card unlock.
Timezone	First Card Unlock is valid in the period of the selected time template.
Status	After First Card Unlock is enabled, the door is in either the Normal mode or Always Open mode .
User	Select the user to hold the first card. Supports selecting a number of users to hold first cards. Any one of them swiping the first card means first card unlock is done.

Step 5 (Optional) Click . The icon changing into indicates **First Card Unlock** is enabled. The newly added **First Card Unlock** is enabled by default.

3.6.1.2 Multi-card Unlock

Users can only unlock the door after defined users or user groups grant access in sequence.

- One group can have up to 50 users, and one person can belong to multiple groups.
- You can add up to four user groups with multi-card unlock permission for a door, with up to 200 users in total and up to 5 valid users.



- First card unlock takes priority over the multi-card unlock, which means if the two rules are both enabled, the first card unlock comes first. We recommend you not assign multi-card unlock permission to first card holders.
- Do not set the **VIP** or **Patrol** type for people in the user group. For details, see "3.3.2 Adding User".

- For details of permission assignment, see "3.4 Configuring Permission".

Step 1 Select **Access Configuration > Advanced Config.**

Step 2 Click the **Multi Card Unlock** tab.

Step 3 Add user group.

- 1) Click **User Group**.

Figure 3-17 User group manager

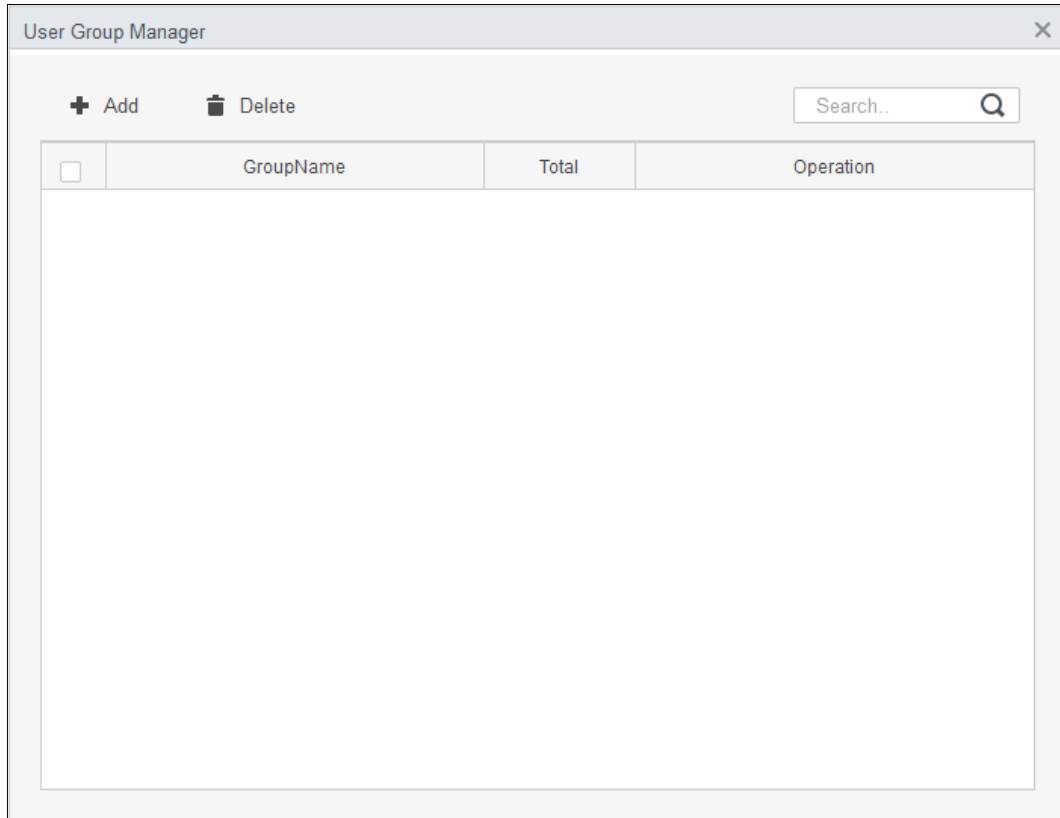

- 2) Click **Add**.

Figure 3-18 User group configuration

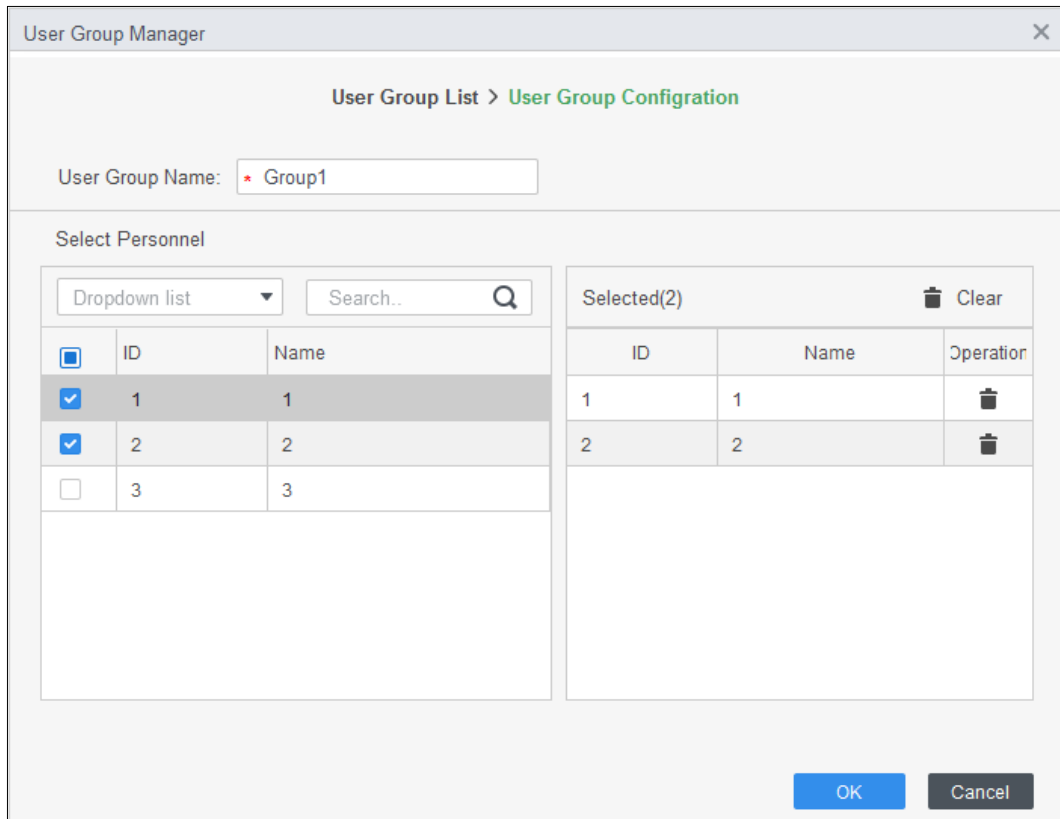

- 3) Set up **User Group Name**. Select users from **User List** and click **OK**. You can select up to 50 users.
- 4) Click at the upper-right corner of the **User Group Manager** page.

Step 4 Configure parameters of multi-card unlock.

- 1) Click **Add**.

Figure 3-19 Multi-card unlock configuration (1)

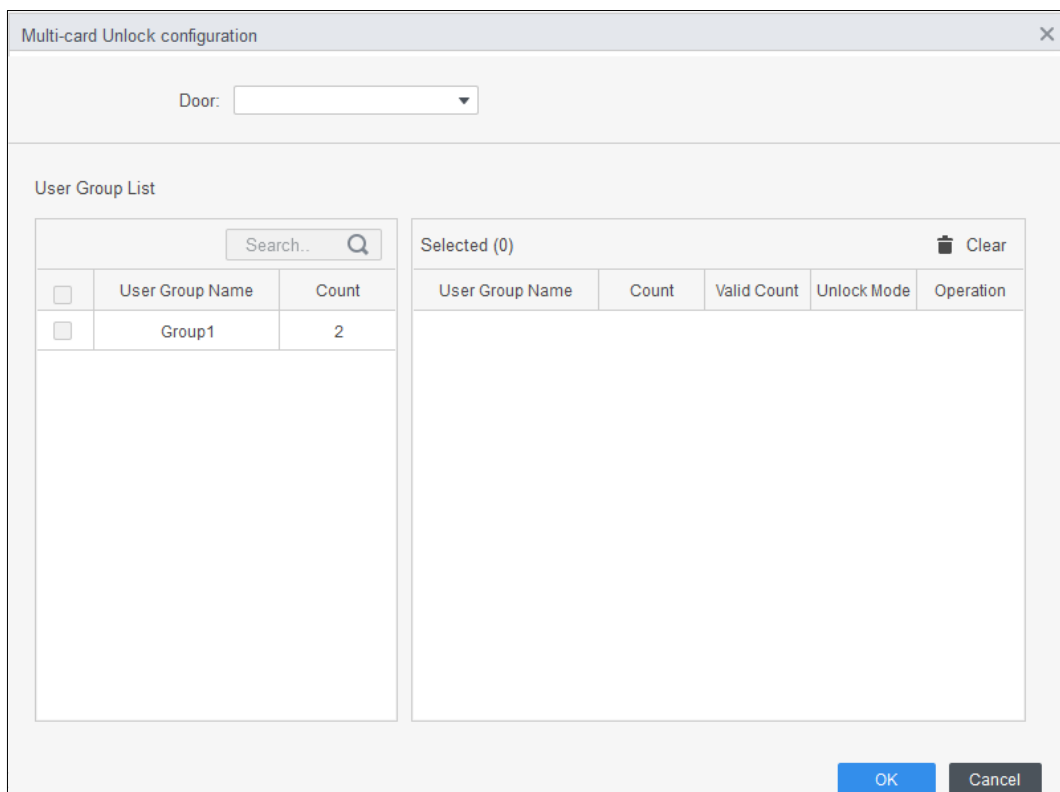

- 2) Select the door.
- 3) Select the user group. You can select up to four groups.

Figure 3-20 Multi-card unlock configuration (2)



- 4) Enter the **Valid Count** for each group to be on site, and then select the **Unlock Mode**.

Click  or  to adjust the group sequence to unlock the door.



- The valid count refers to the number of users in each group that must be on site to swipe their cards. Take Figure 3-17 as an example. The door can be unlocked only after one person of group 1 and 2 people of group 2 have swiped their cards.
- Up to five valid users are allowed.

- 5) Click **OK**.

Step 5 (Optional) Click . The icon changing into  indicates **Multi Card Unlock** is enabled. The newly added **Multi Card Unlock** is enabled by default.

3.6.1.3 Anti-passback

Users must verify their identities both for entry and exit; otherwise an alarm will be triggered. If a person enters with valid identity verification and exits without verification, an alarm will be triggered when they attempt to enter again, and access is denied at the same time. If a person enters without identity verification and exits with verification, exit is denied when they attempt to exit.

Step 1 Select **Access Configuration > Advanced Config**.

Step 2 Click **Add**.

Step 3 Configure parameters.

- 1) Select device and enter device name.
- 2) Select time template.

- 3) Set rest time and the unit is minute.
For example, set the reset time as 30 minutes. If one staff has swiped in but not swiped out, the anti-pass back alarm will be triggered when this staff tends to swipe in again within the 30 minutes. The second swipe-in of this staff is only valid after 30 minutes later.
- 4) Click **In Group** and select the corresponding reader. And then click **Out Group** and select the corresponding reader.
- 5) Click **OK**.
The configuration will issue to device and take effect.

Figure 3-21 Anti-pass back configuration

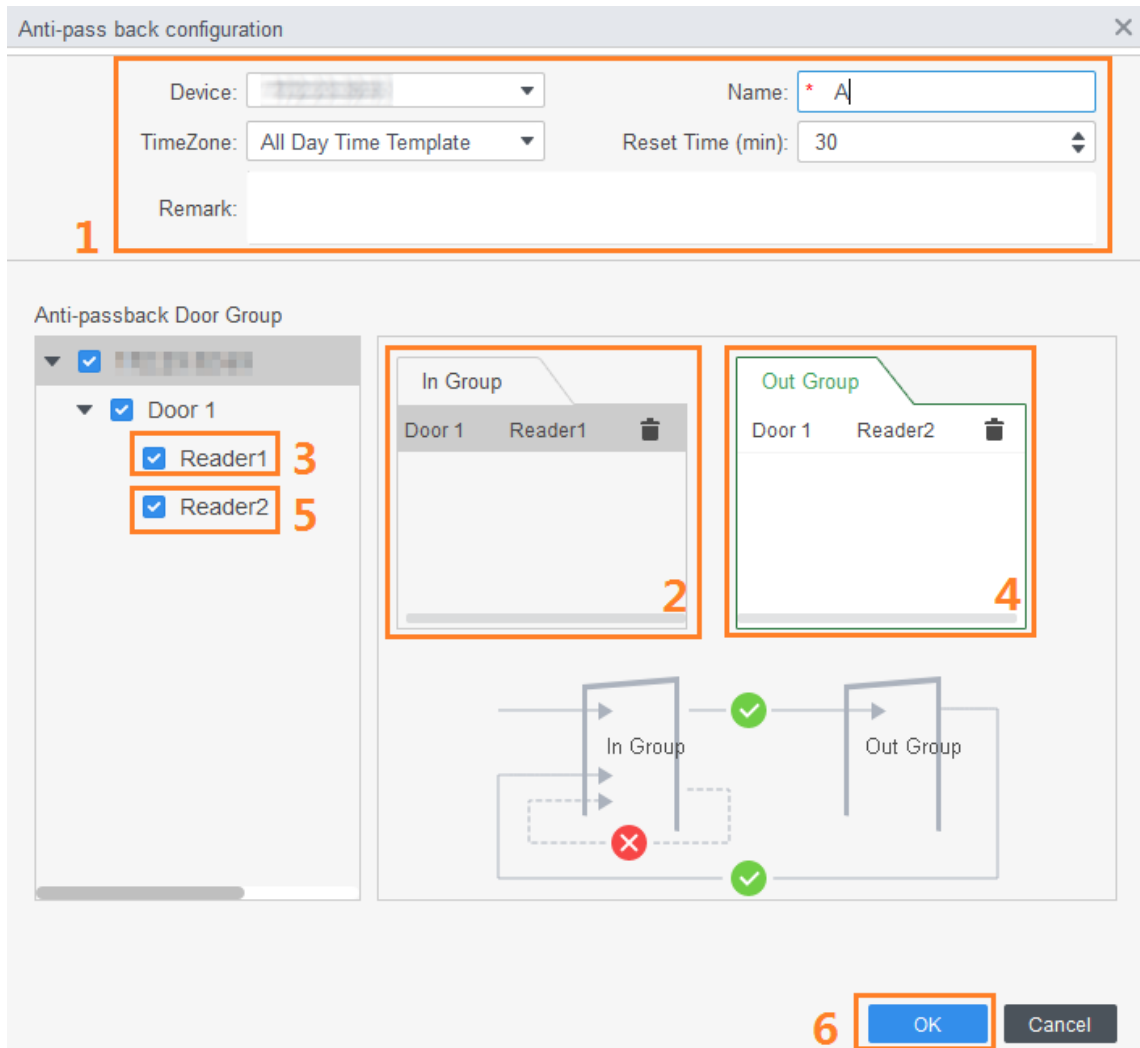

Step 4 (Optional) Click . The icon changing into indicates **Anti-passback** is enabled. The newly added **Anti-passback** is enabled by default.

3.6.1.4 Inter-door Lock

The access through one or more doors depends on the status of another door (or doors). For example, when two doors are interlocked, you can access through one door only when the other door is closed. One device supports two groups of doors with up to 4 doors in each group.

Step 1 Select **Access Configuration > Advanced Config**.

Step 2 Click the **Inter-Lock** tab.



Step 3 Click **Add**.

Step 4 Configure parameters and click **OK**.

- 1) Select device and enter device name.
- 2) Enter remark.
- 3) Click **Add** twice to add two door groups.
- 4) Add doors of the access controller to the needed door group. Click one door group and then click doors to add.
- 5) Click **OK**.

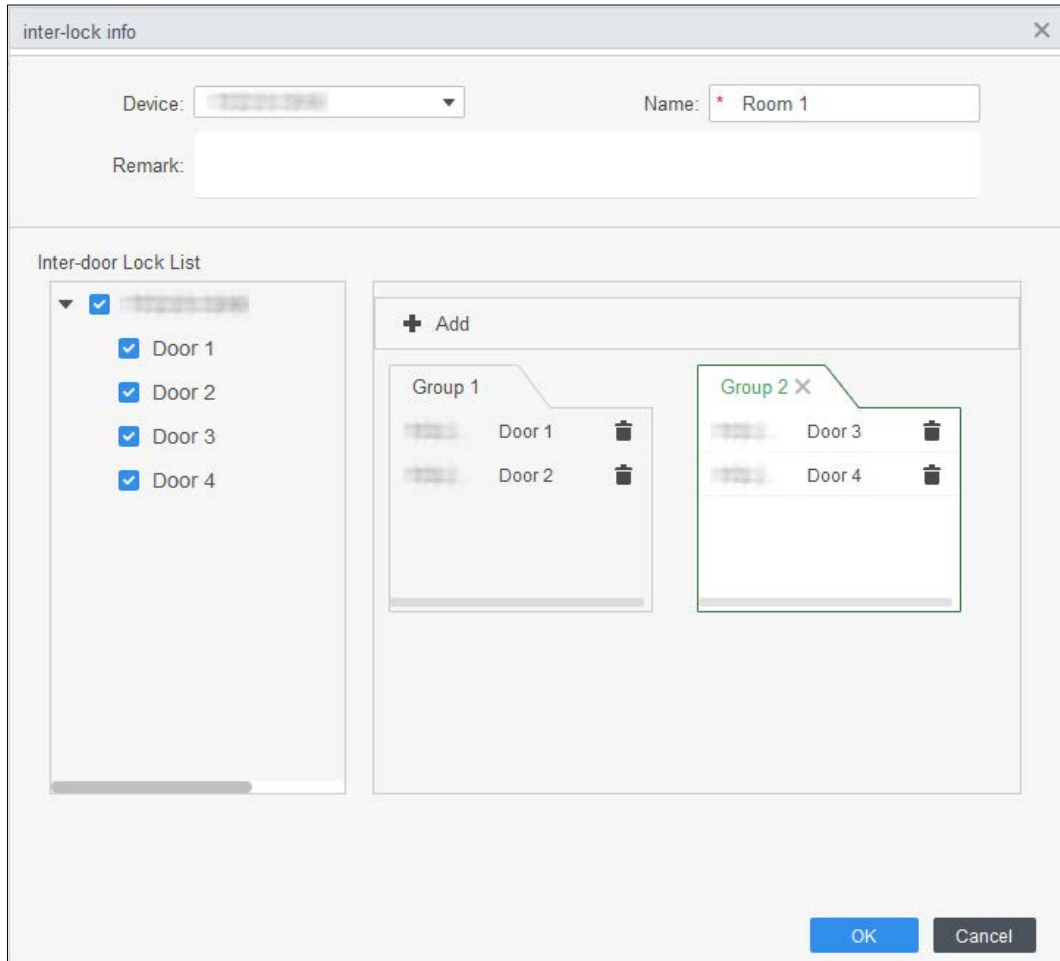
Figure 3-22 Inter-door lock configuration



Step 5 (Optional) Click . The icon changing into , which indicates **Inter-door Lock** is enabled.

The newly added **Inter-door Lock** is enabled by default.

3.6.2 Configuring Access Controller

You can configure access door, such as reader direction, door status and unlock mode.

Step 1 Select **Access Configuration > Access Config**.

Step 2 Click the door that needs to be configured.

Step 3 Configure parameters.

Figure 3-23 Configure access door

Access Door Config

Door: * Door 1

Reader Direction Config: IN Reader1 ⇌ OUT

Status: Normal Always Open Always Close

Keep OpenTimezone: Unopened

Keep Close Timezone: Unopened

Alarm: Intrusion Overtime Duress

Door Sensor:

Administrator Password: *

Remote Verification:

Unlock Hold Interval: 3 Second

Close Timeout: 15 Second

Unlock Mode: or

Card Fingerprint Face Password

Save Cancel

Figure 3-24 Unlock by time period

Timezone set

Monday Tuesday Wednesday Thursday Friday Saturday Sunday

Timezone 1 00:00 — 06:00 Unlock Mode Card / Fingerprint / Face / Password

Timezone 2 06:00 — 10:00 Unlock Mode Card + Fingerprint



Timezone 3 10:00 — 12:00 Unlock Mode Password

Timezone 4 12:00 — 23:00 Unlock Mode Fingerprint

All

OK Cancel

Table 3-3 Parameters of access door

Parameter	Description
Door	Enter door name.
Reader Direction Config	Click  to set reader direction according to actual situations.
Status	Set door status, including Normal , Always Open and Always Close .  It is not the actual door status because the SmartPSS-AC can only send commands to the device. If you want to know the actual door status, enable door sensor.
Keep Open Timezone	Select time template when door is always open.
Keep Close Timezone	Select time template when door is always closed.
Alarm	Enable alarm function and set alarm type, including intrusion, overtime and duress. When alarm enabled, the SmartPSS-AC will receive uploaded message when the alarm is triggered.
Door Sensor	Enable door sensor so that you can know the actual door status. We recommend enabling the function.
Administrator Password	Enable and set the administrator password. You can access by entering the password.
Remote Verification	Enable the function and set the time template, and then the access of person has to be verified remotely through the SmartPSS-AC during the template periods.
Unlock Hold Interval	Set the unlock holding interval. The door will auto close when time is over.
Close Timeout	Set the timeout for alarm. For example, set close timeout as 60 seconds. If the door is not closed for more than 60 seconds, the alarm message will be uploaded.
Unlock Mode	Select unlock mode as needed. <ul style="list-style-type: none"> ● Select And, and select unlock methods. You can open the door by combining the selected unlock methods. ● Select Or and select unlock methods. You can open the door in one of the way that you configured. ● Select Unlock by time period and select unlock mode for each time period. The door can only be opened by the selected method(s) within the defined period.

Step 4 Click **Save**.

3.6.3 Viewing Historical Event

History door events include events both on SmartPSS-AC and devices. Extract history events from devices to make sure all event logs are available to be searched for.

Step 1 Add the needed personnel to the SmartPSS-AC.

Step 2 Click **Access Configuration > History Event** on the homepage.

Step 3 Click on the **Access Manager** page.

Step 4 Extract events from door device to the local. Click **Extract**, set the time, select the door device, and then click **Extract Now**.



You can select multiple devices at one time to extract events.

Figure 3-25 Extract events

Time	User ID	Name	Card No.	Device	Door	Event	Verification Method	Access direction	Operation
2020-06-18 10:45:42						External Alarm			
2020-06-18 10:34:12						Tamper Alarm			
2020-06-18 10:31:17						Door Unlocked Alarm			
2020-06-18 10:13:20						Close Door			
2020-06-18 10:13:17						Duress			
2020-06-18 10:13:17						or is unlocked			
2020-06-18 10:13:17			BCDFDE66			Card Unlock	Card	IN	
2020-06-18 10:01:25						External Alarm			
2020-06-18 08:54:08						External Alarm			
2020-06-18 08:53:31						External Alarm			
2020-06-18 08:53:16						External Alarm			
2020-06-18 08:53:09						External Alarm			
2020-06-18 08:53:08						External Alarm			
2020-06-18 08:52:37						External Alarm			
2020-06-18 08:52:35						External Alarm			
2020-06-18 08:52:11						External Alarm			
2020-06-18 08:39:14	30080	30080	134			Face Recognition	Face Recog...	IN	
2020-06-18 08:39:05	30080	30080	134			Face Recognition	Face Recog...	IN	
2020-06-18 08:32:42						Unregistered or lost	Face Recog...		
2020-06-18 08:30:55						Close Door			

Step 5 Set filtering conditions, and then click **Search**.

Figure 3-26 Search for events by filtering conditions

The screenshot shows a search interface with the following elements:

- A search bar at the top with the placeholder text "Search.." and a magnifying glass icon.
- A dropdown menu for "Default Group" with a tree icon.
- A dropdown menu for a door, currently showing "Door 1" with a door icon.
- A section labeled "Event:" containing two dropdown menus: the first is set to "Abnormal" and the second is set to "All".
- A section labeled "Time:" with a text input field containing "05/07 00:00-05/07 23:59" and a calendar icon.
- A section labeled "User ID/C..." with a text input field containing "1".
- A section labeled "Name:" with a text input field containing "1".
- A section labeled "Departme..." with a dropdown menu set to "Company\DepartmentA".
- A blue "Search" button at the bottom.

3.7 Access Management

3.7.1 Remotely Opening and Closing Door

You can remotely control door through SmartPSS AC.

Step 1 Click **Access Manager** on the homepage. (Or click **Access Guide** > )

Step 2 Remotely control the door. There are two methods.

- Method 1: Select the door, right click and select **Open**.

Figure 3-27 Remotely control (method 1)

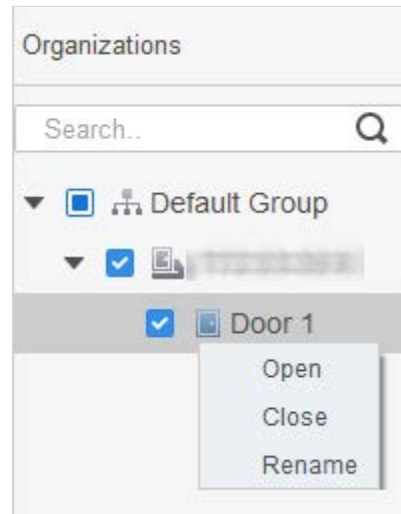



- Method 2: Click  or  to open or close the door.

Figure 3-28 Remotely control (method 2)



Step 3 View door status by **Event Info** list.



- Event filtering: Select the event type in the **Event Info**, and the event list displays events of the selected types. For example, select **Alarm**, and the event list only displays alarm events.
- Event refresh locking: Click  next to **Event Info** to lock or unlock the event list, and then the real-time events cannot be viewed.
- Event deleting: Click  next to **Event Info** to clear all events in the event list.

3.7.2 Setting Door Status

After setting always open status or always close status, the door remains open or closed all the time. You can click **Normal** to restore the door status to normal so that users can unlock the door after identity verification.

Step 1 Click **Access Manager** on the homepage. (Or click **Access Guide** > ).

Step 2 Select the door, and then click **Always Open** or **Always Close**.

Figure 3-29 Set always open or always close

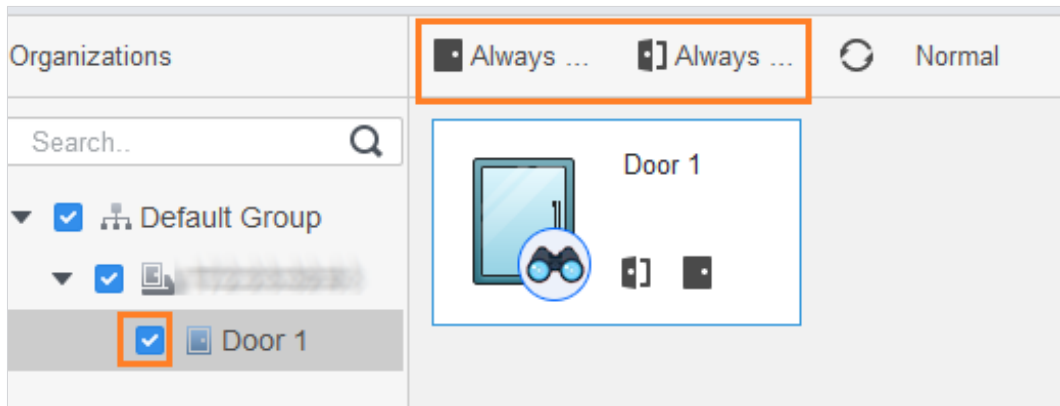

3.7.3 Configuring Alarm Linkage

After you configure alarm linkage, alarms will be triggered. For details, refer to the user manual of SmartPss AC. This section uses intrusion alarm as an example.

- Configure external alarm linkages connected to the access controller, such as smoke alarm.
- Configure linkages of access controller events.
 - ◇ Alarm event
 - ◇ Abnormal event
 - ◇ Normal event



For anti-pass back function, set the anti-pass back mode in **Abnormal of Event Config**, and then configure the parameters in **Advanced Config**. For details, see "3.5.1 Configuring Advanced Functions".

Step 1 Click **Event Config** on the homepage.

Step 2 Select the door and select **Alarm Event > Intrusion Event**.

Step 3 Click next to **Intrusion Alarm** to enable the function.

Step 4 Configure intrusion alarm linkage actions as needed.

- Enable alarm sound.
Click the **Notify** tab, and click next to **Alarm Sound**. When intrusion event happens, the access controller warns with alarm sound.
- Send alarm mail.
 - 1) Enable **Send Mail** and confirm to set SMTP. The **System Settings** page is displayed.
 - 2) Configure SMTP parameters, such as server address, port number, and encrypt mode.
When intrusion events occur, the system sends alarm notifications through mails to the specified receiver.

Figure 3-30 Configure intrusion alarm

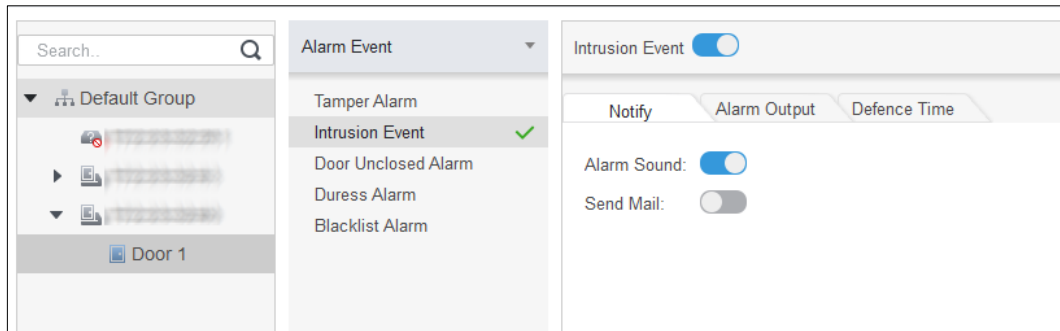

- Configure alarm I/O.
 - 1) Click the **Alarm Output** tab.
 - 2) Select the device which supports alarm in, select alarm-in interface, and then enable **External Alarm**.
 - 3) Select the device which supports alarm out, then select alarm-out interface.
 - 4) Enable **Auto Open** for the alarm linkage.
 - 5) Set the duration.

Figure 3-31 Configure alarm linkage

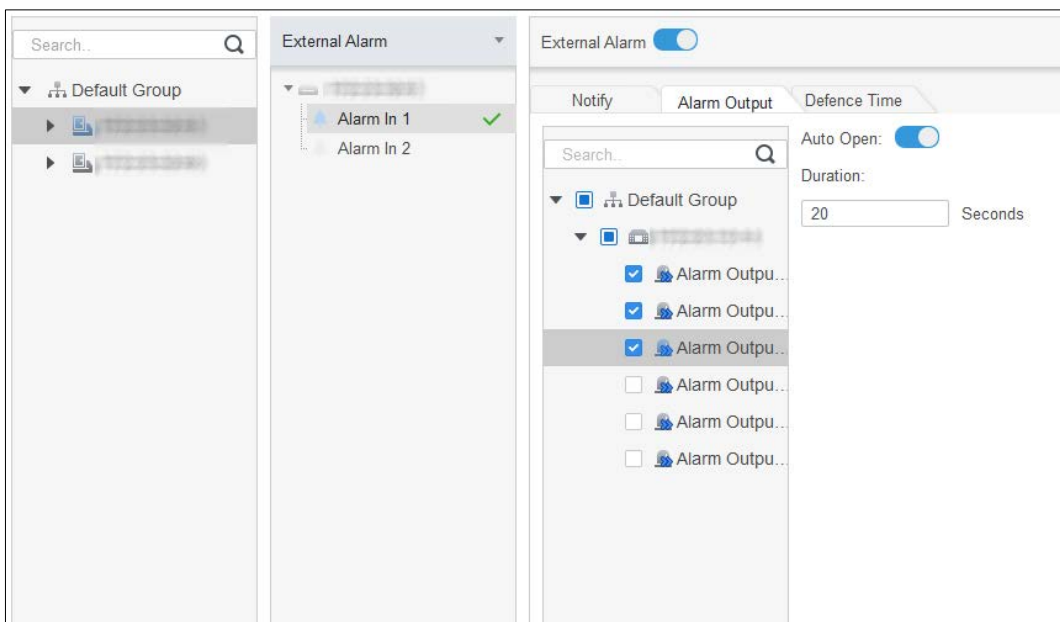

- Set arming time. There are two methods.
 - ◇ Method 1: Move the cursor to set periods. When the cursor is pencil, click to add periods; when the cursor is eraser, click to remove periods. The green area is the arming periods.

Figure 3-32 Set arming time (method 1)

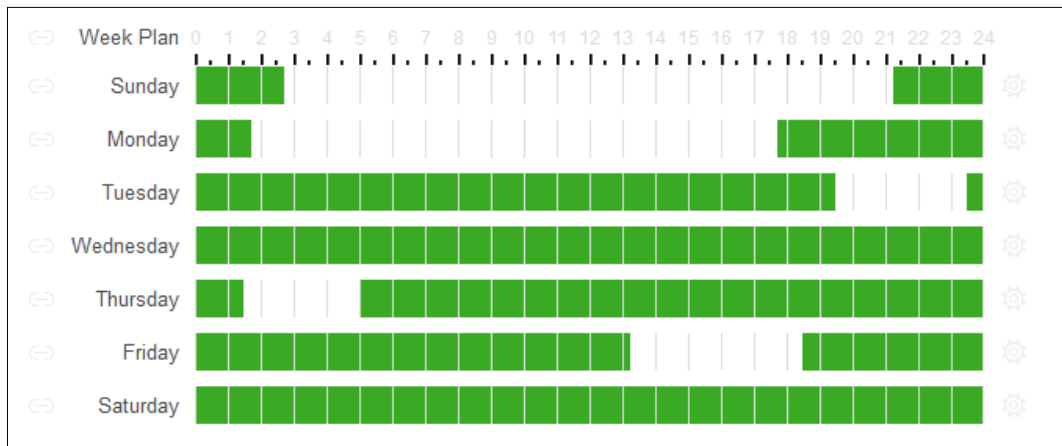

- ◇ Method 2: Click  to set periods, and then click **OK**.

Figure 3-33 Set arming time (method 2)

Time Editor

Timezone 1	0:00:00	-	2:45:00
Timezone 2	11:30:00	-	14:15:00
Timezone 3	21:15:00	-	23:59:59
Timezone 4	0:00:00	-	0:00:00
Timezone 5	0:00:00	-	0:00:00
Timezone 6	0:00:00	-	0:00:00

Check All

Sun Mon Tue Wed
 Thu Fri Sat

OK Cancel

Step 5 (Optional) If you want to set the same arming periods for other access controller, click **Copy To**, select the access controller, and then click **OK**.

Step 6 Click **Save**.

4 ConfigTool Configuration

ConfigTool is mainly used to configure and maintain the device.



Do not use ConfigTool and SmartPSS AC at the same time, otherwise it may cause abnormal results when you searching for devices.

4.1 Initialization



Before initialization, make sure the Controller and the computer are on the same network.

Step 1 Search for the Controller through the ConfigTool.

- 1) Double-click ConfigTool to open it.
- 2) Click **Search setting**, enter the network segment range, and then click OK.
- 3) Select the uninitialized Controller, and then click Initialize.



Figure 4-1 Search for the device

The screenshot shows a 'Setting' dialog box with the following fields and options:

- Checked checkbox: **Current Segment Search**
- Unchecked checkbox: **Other Segment Search**
- Start IP: [Input field]
- End IP: [Input field] 5
- Username: **admin**
- Password: [Masked field]
- OK button

Step 2 Select the uninitialized Controller, and then click **Initialize**.

Step 3 Click **OK**.

The system starts initialization.  indicates initialization success,  indicates initialization failed.

Step 4 Click **Finish**.

4.2 Adding Devices

You can add one or multiple devices according to your actual needs.



Make sure that the device and the PC where the ConfigTool is installed are connected; otherwise the tool cannot find the device.

4.2.1 Adding Device Individually

Step 1 Click .

Step 2 Click **Manual Add**.

Step 3 Select **IP Address** from **Add Type**.

Figure 4-2 Manual add (IP address)

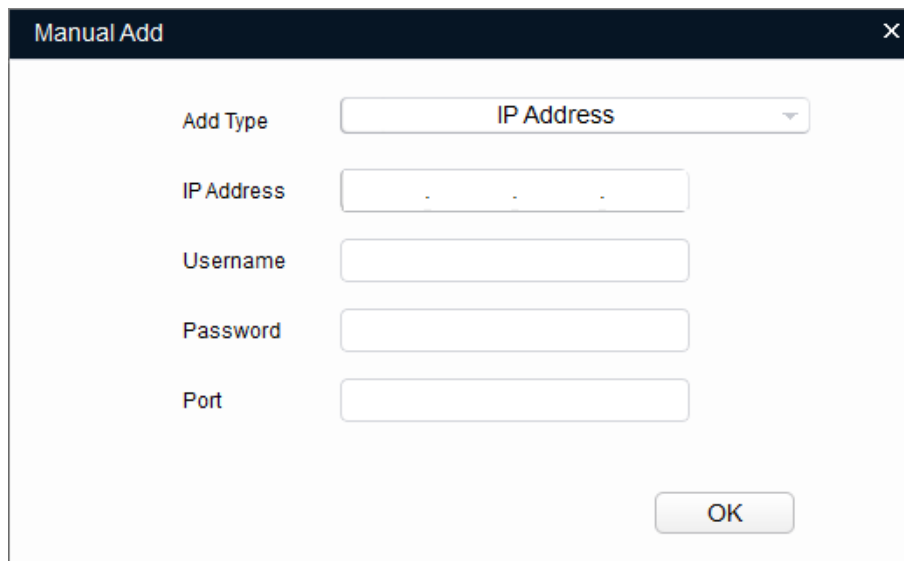

Step 4 Set the Controller parameters.

Table 4-1 Manual add parameters

Add Method	Parameter	Description
IP Address	IP Address	The IP address of the device. It is 192.168.1.108 by default.
	Username	The username and password for device login.
	Password	
	Port	The device port number.

Step 5 Click **OK**.

The newly added device is displayed in the device list.

4.2.2 Adding Devices in Batches

You can add multiple devices through searching devices or importing the template.

4.2.2.1 Adding by Searching

You can add multiple devices through searching the current segment or other segments.



You can set the filtering conditions to search the wanted device quickly.

Step 1 Click  **Search setting**.

Figure 4-3 Setting

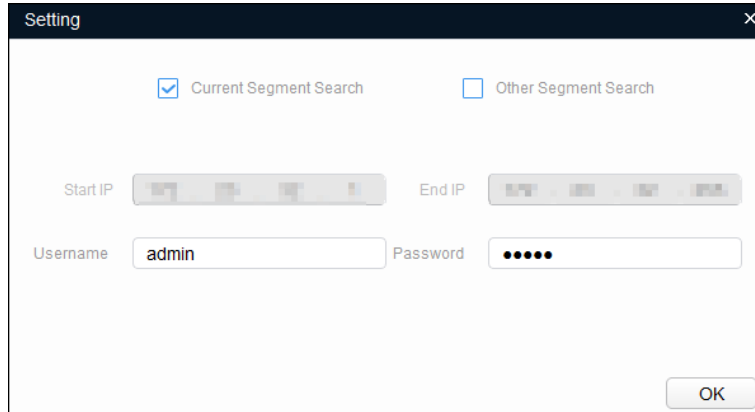

Step 2 Select the searching way. Both the following two ways are selected by default.

- Search current segment
Select **Current Segment Search**. Enter the username and password. The system will search for devices accordingly.
- Search other segment
Select **Other Segment Search**. Enter the start IP address and end IP address. Enter the username and the password. The system will search for devices accordingly.



- If you select both **Current Segment Search** and **Other Segment Search**, the system searches for devices on the both segments.
- The username and the password are the ones used to log in when you want to modify IP, configure the system, update the device, restart the device, and more.

Step 3 Click **OK** to start searching devices.

The searched devices will be displayed in the device list.



- Click  to refresh the device list.
- The system saves the searching conditions when exiting the software and reuses the same conditions when the software is launched next time.

4.2.2.2 Adding by Importing Device Template

You can add the devices by importing an Excel template. You can import up to 1000 devices.



Close the template file before importing the devices; otherwise the import will fail.

- Step 1** Click , select one device, and then click **Export** to export a device template.
- Step 2** Follow the on-screen instructions to save the template file locally.
- Step 3** Open the template file, change the existing device information to the information of devices you want to add.
- Step 4** Import the template. Click **Import**, select the template and click **Open**.
The system starts importing the devices.
- Step 5** Click **OK**.
The newly imported devices display in the device list.

4.3 Configuring Access Controller



The screenshots and parameters might be different depending on the device types and models.

- Step 1** Click  on the main menu.
- Step 2** Click the access controller that you want to configure in the device list, and then click **Get Device Info**.
- Step 3** (Optional) If the Login page shows, enter the username and password, and then click **OK**.
- Step 4** Set access controller parameters.



Figure 4-4 Configure access controller

Table 4-2 Access controller parameters

Parameter
Channel
Card No.
TCP Port

Parameter
SysLog
CommPort
Bitrate
OSDPEnable

Step 5 (Optional) Click **Apply to**, select the devices that you need to sync the configured parameters to, and then click **Config**.

If succeeded,  is displayed on the right side of the device; if failed,  is displayed. You can click the icon to view detailed information.

4.4 Changing Device Password

You can modify the device login password.

Step 1 Click  on the menu bar.

Step 2 Click the **Device Password** tab.

Figure 4-5 Device password

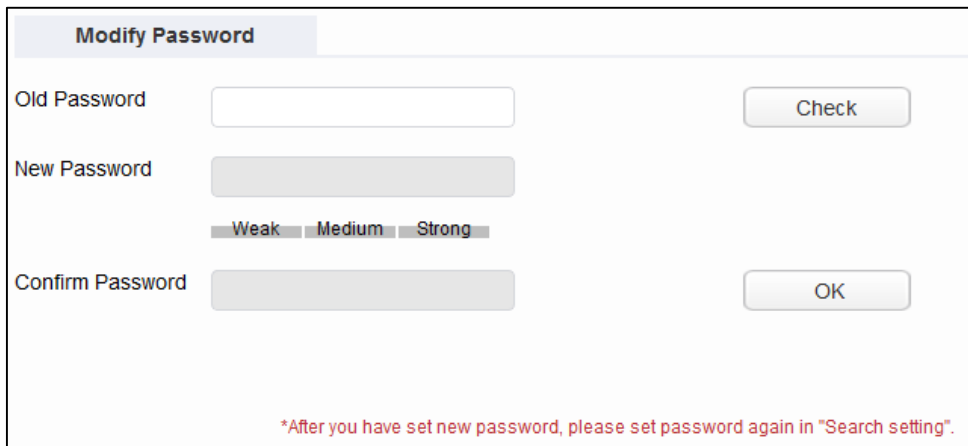

Modify Password

Old Password

New Password

Weak Medium Strong

Confirm Password

**After you have set new password, please set password again in "Search setting".*

Step 3 Click  next to the device type, and then select one or multiple devices.



If you select multiple devices, the login passwords must be the same.

Step 4 Set the password.

Follow the password security level hint to set a new password.

Table 4-3 Password parameters

Parameter	Description
Old Password	Enter the device old password. To make sure that the old password is entered correctly, you can click Check to verify.
New Password	Enter the new password for the device. There is an indication for the strength of the password. The password must consist of 8 to 32 non-blank characters and contain at least two types of characters among upper case, lower case, number, and special character (excluding ' " ; : &).
Confirm Password	Confirm the new password.

Step 5 Click **OK** to complete modification.

Appendix 1 Cybersecurity Recommendations

Mandatory actions to be taken for basic device network security:

1. Use Strong Passwords

Please refer to the following suggestions to set passwords:

- The length should not be less than 8 characters.
- Include at least two types of characters; character types include upper and lower case letters, numbers and symbols.
- Do not contain the account name or the account name in reverse order.
- Do not use continuous characters, such as 123, abc, etc.
- Do not use overlapped characters, such as 111, aaa, etc.

2. Update Firmware and Client Software in Time

- According to the standard procedure in Tech-industry, we recommend to keep your device (such as NVR, DVR, IP camera, etc.) firmware up-to-date to ensure the system is equipped with the latest security patches and fixes. When the device is connected to the public network, it is recommended to enable the "auto-check for updates" function to obtain timely information of firmware updates released by the manufacturer.
- We suggest that you download and use the latest version of client software.

"Nice to have" recommendations to improve your device network security:

1. Physical Protection

We suggest that you perform physical protection to device, especially storage devices. For example, place the device in a special computer room and cabinet, and implement well-done access control permission and key management to prevent unauthorized personnel from carrying out physical contacts such as damaging hardware, unauthorized connection of removable device (such as USB flash disk, serial port), etc.

2. Change Passwords Regularly

We suggest that you change passwords regularly to reduce the risk of being guessed or cracked.

3. Set and Update Passwords Reset Information Timely

The device supports password reset function. Please set up related information for password reset in time, including the end user's mailbox and password protection questions. If the information changes, please modify it in time. When setting password protection questions, it is suggested not to use those that can be easily guessed.

4. Enable Account Lock

The account lock feature is enabled by default, and we recommend you to keep it on to guarantee the account security. If an attacker attempts to log in with the wrong password several times, the corresponding account and the source IP address will be locked.

5. Change Default HTTP and Other Service Ports

We suggest you to change default HTTP and other service ports into any set of numbers between 1024–65535, reducing the risk of outsiders being able to guess which ports you are using.

6. Enable HTTPS

We suggest you to enable HTTPS, so that you visit Web service through a secure communication channel.

7. MAC Address Binding

We recommend you to bind the IP and MAC address of the gateway to the device, thus reducing the risk of ARP spoofing.

8. Assign Accounts and Privileges Reasonably

According to business and management requirements, reasonably add users and assign a minimum set of permissions to them.

9. Disable Unnecessary Services and Choose Secure Modes

If not needed, it is recommended to turn off some services such as SNMP, SMTP, UPnP, etc., to reduce risks.

If necessary, it is highly recommended that you use safe modes, including but not limited to the following services:

- SNMP: Choose SNMP v3, and set up strong encryption passwords and authentication passwords.

- SMTP: Choose TLS to access mailbox server.
- FTP: Choose SFTP, and set up strong passwords.
- AP hotspot: Choose WPA2-PSK encryption mode, and set up strong passwords.

10. Audio and Video Encrypted Transmission

If your audio and video data contents are very important or sensitive, we recommend that you use encrypted transmission function, to reduce the risk of audio and video data being stolen during transmission.

Reminder: encrypted transmission will cause some loss in transmission efficiency.

11. Secure Auditing

- Check online users: we suggest that you check online users regularly to see if the device is logged in without authorization.
- Check device log: By viewing the logs, you can know the IP addresses that were used to log in to your devices and their key operations.

12. Network Log

Due to the limited storage capacity of the device, the stored log is limited. If you need to save the log for a long time, it is recommended that you enable the network log function to ensure that the critical logs are synchronized to the network log server for tracing.

13. Construct a Safe Network Environment

In order to better ensure the safety of device and reduce potential cyber risks, we recommend:

- Disable the port mapping function of the router to avoid direct access to the intranet devices from external network.
- The network should be partitioned and isolated according to the actual network needs. If there are no communication requirements between two sub networks, it is suggested to use VLAN, network GAP and other technologies to partition the network, so as to achieve the network isolation effect.
- Establish the 802.1x access authentication system to reduce the risk of unauthorized access to private networks.
- Enable IP/MAC address filtering function to limit the range of hosts allowed to access the device.